

MINI_LINE 42 TRACK

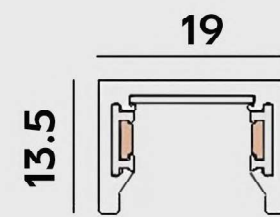

MINI_LINE 42 TRACK S

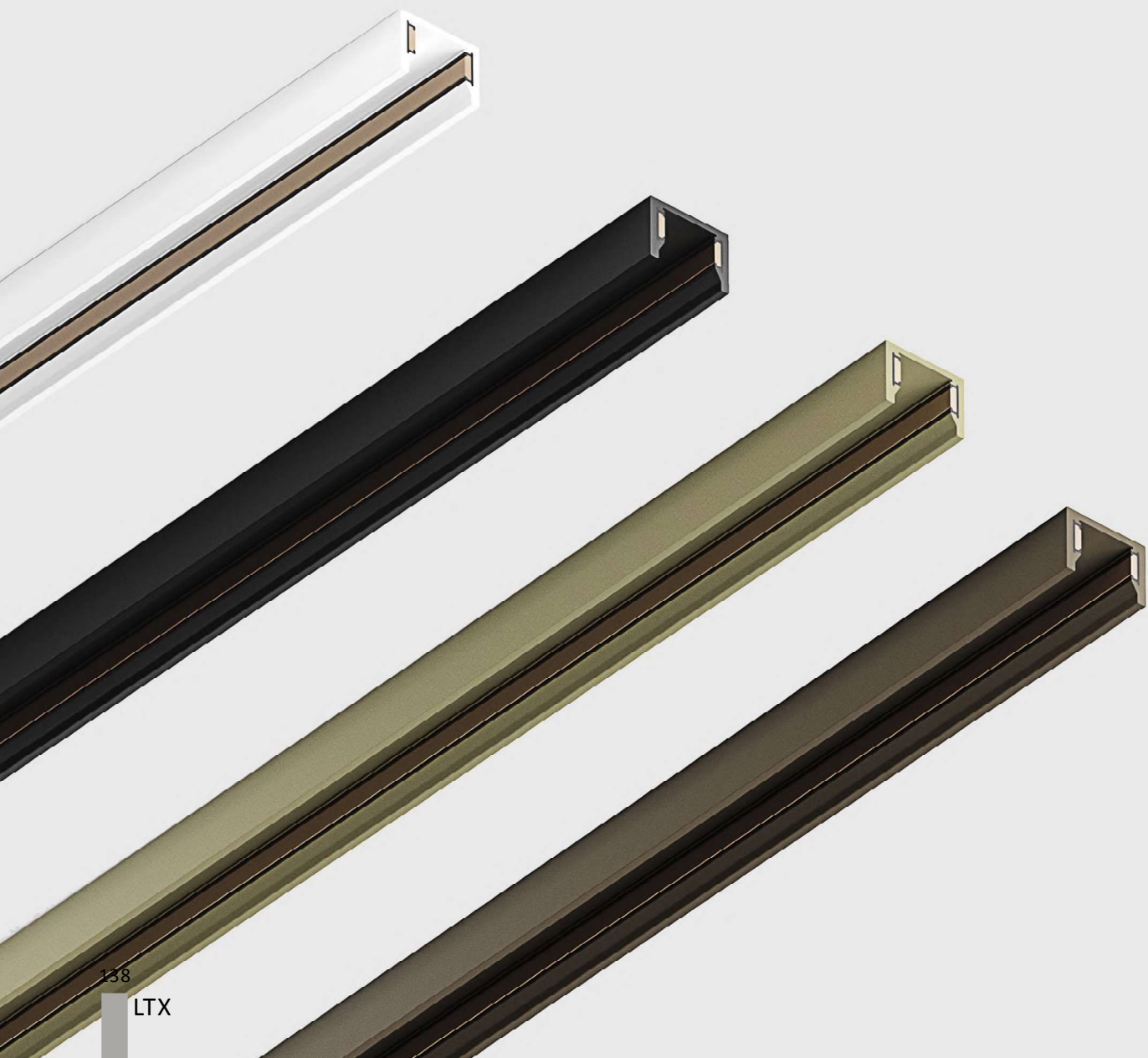
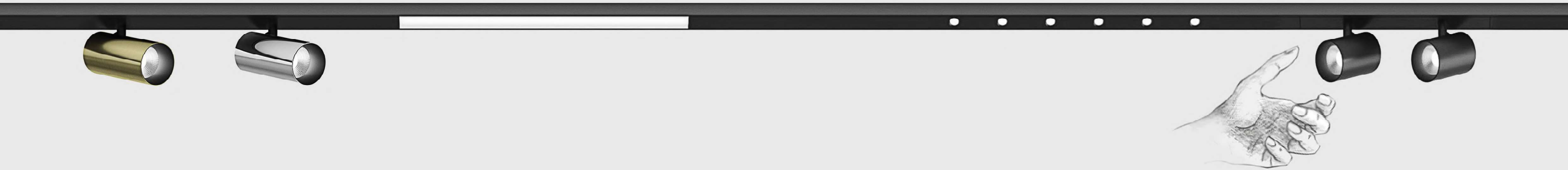
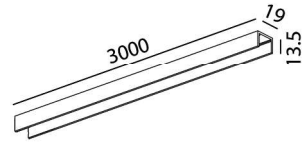

CE ENEC IP20 42V EXCL

MATERIAL | AL

	Code	Dimensions (mm): LxWxH	Color
Surface track	07.S300.WH	3000 x 19 x 13,5	White
(End caps 2pcs included)	07.S300.BK	3000 x 19 x 13,5	Black

(i) » 318

MINI_LINE 42 TRACK S

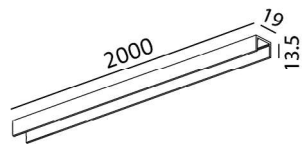

CE ENEC IP20 42V EXCL

MATERIAL | AL

	Code	Dimensions (mm): LxWxH	Color
Surface track	07.S200.LG	2000 x 19 x 13,5	Like gold
(End caps 2pcs included)	07.S200.LB	2000 x 19 x 13,5	Like brass

(i) » 318

MINI_LINE 42 CORNER S HR

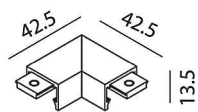

CE ENEC IP20 42V

MATERIAL | AL

	Code	Color
Surface «L» track connector	07.S90HR.WH	White
	07.S90HR.BK	Black
	07.S90HR.LG	Like gold
	07.S90HR.LB	Like brass

(i) » 318

MINI_LINE 42 CORNER S IN

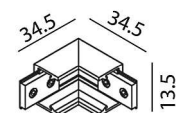
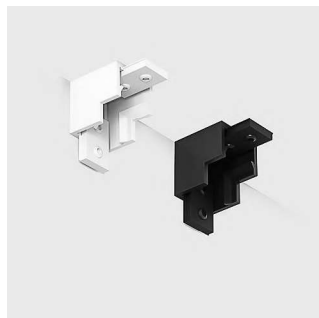

CE ENEC IP20 42V

MATERIAL | AL

	Code	Color
Surface «L» connector	07.S90IN.WH	White
Ceiling to Wall in-installation	07.S90IN.BK	Black

(i) » 318

MINI_LINE 42 CORNER S OUT

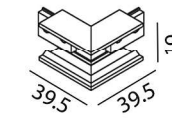

CE ENEC IP20 42V

MATERIAL | AL

	Code	Color
Surface «L» track connector	07.S90OUT.WH	White
Wall to Wall out-installation	07.S90OUT.BK	Black

(i) » 318

MINI_LINE 42 MEC JOINT

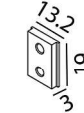

CE ENEC IP20

MATERIAL | AL

	Code	Color
Mechanical linear connector	07.R/SLNCON.WH	White
for track	07.R/SLNCON.BK	Black

(i) » 318

MINI_LINE 42 END CAP S

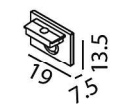
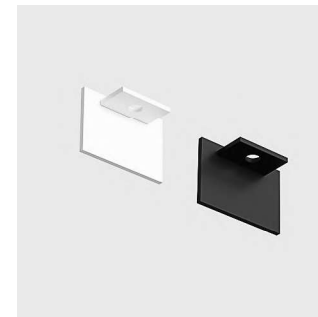

CE ENEC IP20

MATERIAL | PC

	Code	Color
End cap for surface track	07.R/SECAP.WH	White
2 pcs/set	07.R/SECAP.BK	Black
	07.SECAP.LG	Like gold
	07.SECAP.LB	Like brass

(i) » 318

MINI_LINE 42 COVER R/S

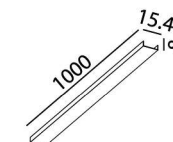
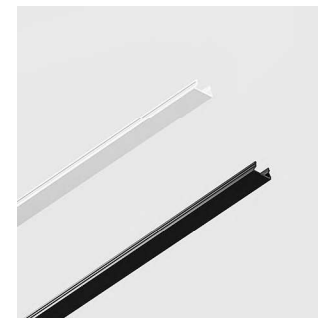

CE ENEC IP20

MATERIAL | PC

	Code	Dimensions (mm): LxWxH	Color
Track cover	07.R/SCOV100.WH	1000 x 15,4 x 8	White
for surface	07.R/SCOV100.BK	1000 x 15,4 x 8	Black

(i) » 318

MINI_LINE 42 ELECTRICAL JOINT FLEX

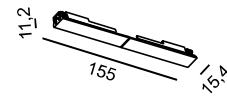

Electrical joint flex
connector for tack

Code	Color
07.S2LE.WH	White
07.S2LE.BK	Black

CE ENEC IP20 42V

MATERIAL | AL

» 318

MINI_LINE 42 LIVE END 500

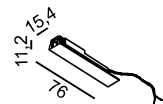
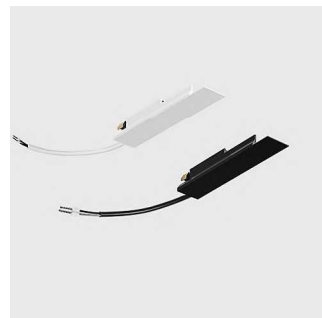

Feed cable, L 300mm

Code	Color
07.SLE50.WH	White
07.SLE50.BK	Black

CE ENEC IP20 42V

MATERIAL | AL

» 318

INSTALLATION SURFACE TRACK SYSTEM MINI_LINE 42

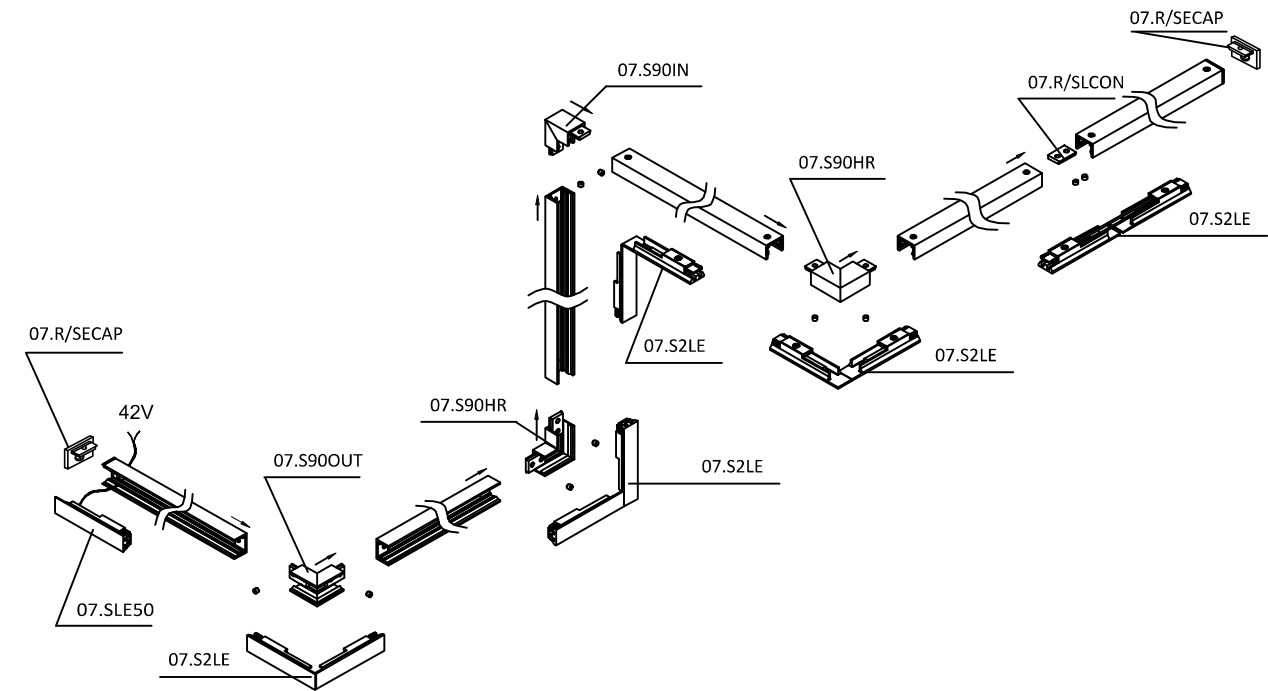

! Every 10 meters of track must be connected to a separate power supply adapter. Maximum permissible current for one electrical circuit - 5.7A (240W)

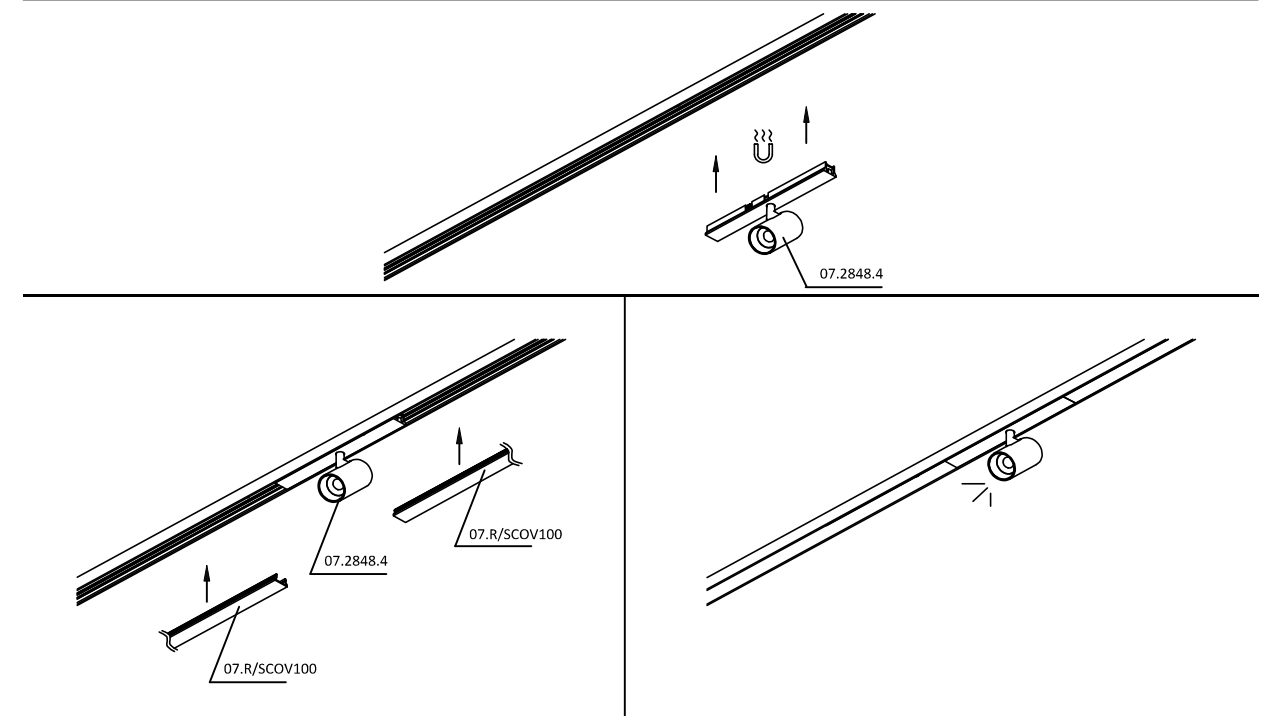

MINI_LINE 42 LINEA 300

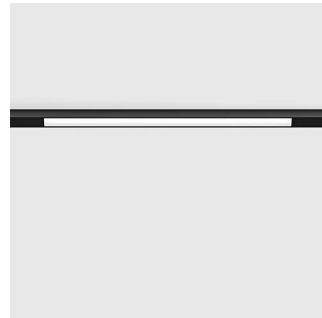

Code	Product Lumen	Power Watt	Color T (K)	CRI	Color
07.3000.6.930.WH	395	6	3000	>90	White
07.3000.6.930.BK	395	6	3000	>90	Black
07.3000.6.940.WH	395	6	4000	>90	White
07.3000.6.940.BK	395	6	4000	>90	Black

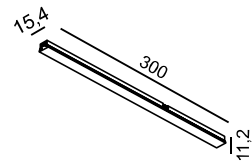

MATERIAL | AL PC

[i](#) » 318

MINI_LINE 42 LINEA 600

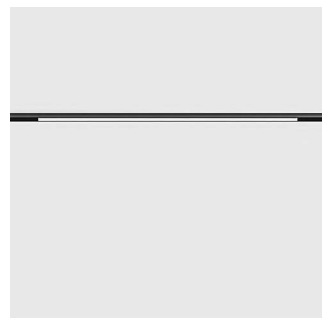

Code	Product Lumen	Power Watt	Color T (K)	CRI	Color
07.6000.12.930.WH	790	12	3000	>90	White
07.6000.12.930.BK	790	12	3000	>90	Black

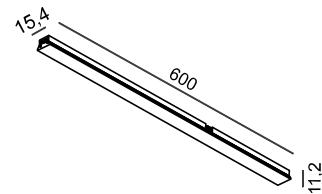

MATERIAL | AL PC

[i](#) » 318

MINI_LINE 42 LINEA 900



Code	Product Lumen	Power Watt	Color T (K)	CRI	Color
07.9000.18.930.WH	1185	18	3000	>90	White
07.9000.18.930.BK	1185	18	3000	>90	Black

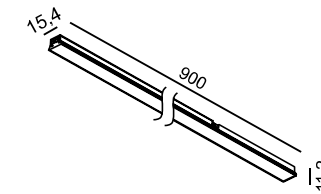

MATERIAL | AL PC

[i](#) » 318

MINI_LINE 42 LINEA 1200

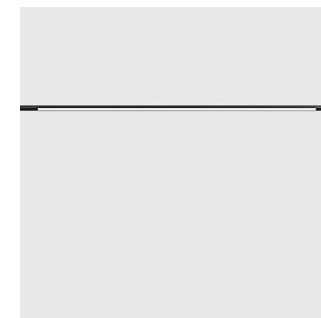

Code	Product Lumen	Power Watt	Color T (K)	CRI	Color
07.1200.24.930.WH	1580	24	3000	>90	White
07.1200.24.930.BK	1580	24	3000	>90	Black

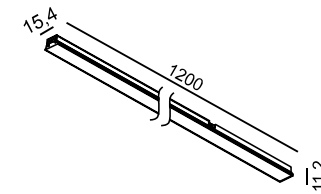

MATERIAL | AL PC

[i](#) » 318



07.3000.6.930.WH

07.3000.6.930.BK

MINI_LINE 42 COMFORT 300

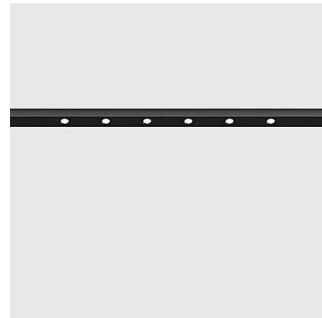

Code	Product Lumen	Power Watt	Color T (K)	CRI	Color
07.3001.4.930.WH	390	4	3000	>90	White
07.3001.4.930.BK	390	4	3000	>90	Black
07.3001.4.940.WH	390	4	4000	>90	White
07.3001.4.940.BK	390	4	4000	>90	Black

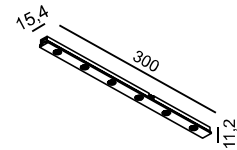

MATERIAL | AL PC

[i](#) » 318

MINI_LINE 42 COMFORT 600

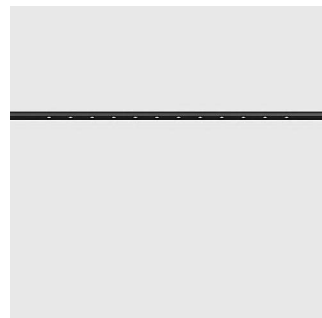

Code	Product Lumen	Power Watt	Color T (K)	CRI	Color
07.6001.8.930.WH	780	8	3000	>90	White
07.6001.8.930. BK	780	8	3000	>90	Black

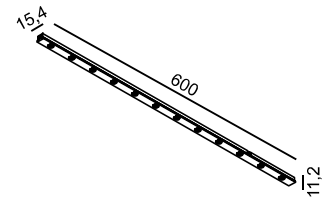

MATERIAL | AL PC

[i](#) » 318

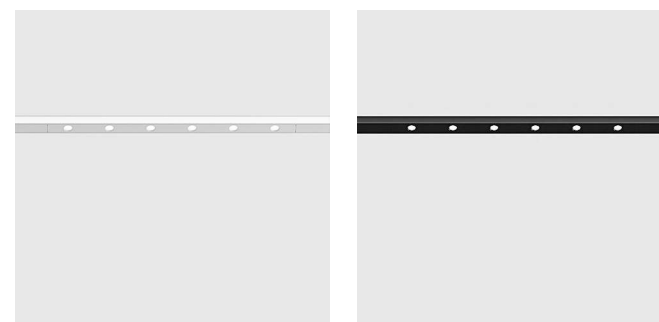

07.3001.4.930.WH

07.3001.4.930.BK



MINI_LINE 42 TUB XS A

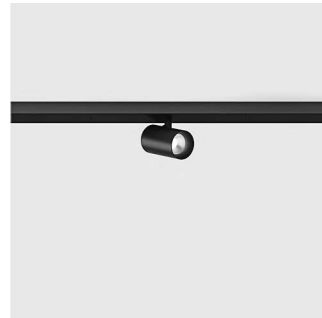

Code	Product Lumen	Power Watt	Color T (K)	CRI	Color
07.2848.4.930.WH	426	3,5	3000	>90	White
07.2848.4.930.BK	426	3,5	3000	>90	Black

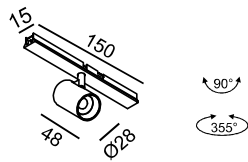

MATERIAL | AL PC

i » 318

MINI_LINE 42 TUB XS A X2

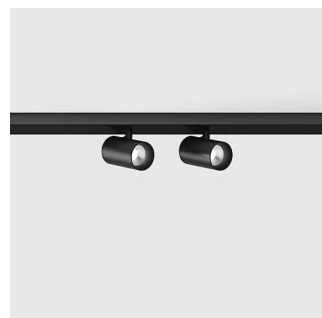

Code	Product Lumen	Power Watt	Color T (K)	CRI	Color
07.2848.7.930.WH	2 x 426	2 x 3,5	3000	>90	White
07.2848.7.930.BK	2 x 426	2 x 3,5	3000	>90	Black

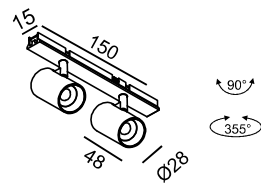

MATERIAL | AL PC

i » 318



07.2848.7.930.WH

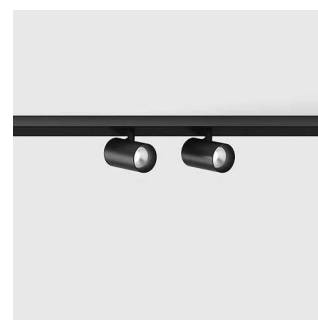

07.2848.7.930.BK

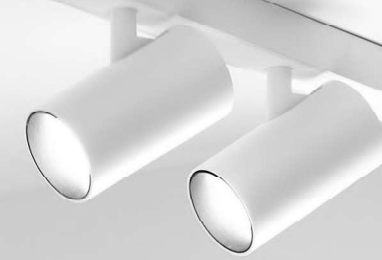

MINI_LINE 42 TUB S A



Code	Product Lumen	Power Watt	Color T (K)	CRI	Color
07.3270.5.930.WH	642	5	3000	>90	White
07.3270.5.930.BK	642	5	3000	>90	Black
07.3270.5.930.BR	642	5	3000	>90	Brass
07.3270.5.930.CR	642	5	3000	>90	Chrome
07.3270.5.940.WH	642	5	4000	>90	White
07.3270.5.940.BK	642	5	4000	>90	Black

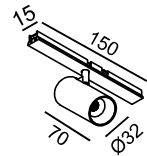

MATERIAL | AL PC

i » 318

MINI_LINE 42 TUB S A X2

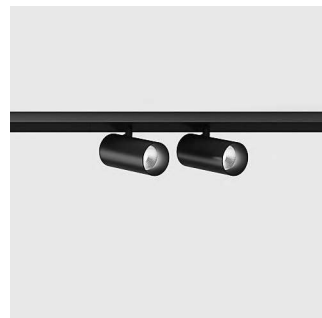

Code	Product Lumen	Power Watt	Color T (K)	CRI	Color
07.3270.10.930.WH	2 x 642	2 x 5	3000	>90	White
07.3270.10.930.BK	2 x 642	2 x 5	3000	>90	Black
07.3270.10.940.WH	2 x 642	2 x 5	4000	>90	White
07.3270.10.940.BK	2 x 642	2 x 5	4000	>90	Black

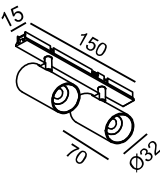

MATERIAL | AL PC

i » 318



07.3270.5.930.WH

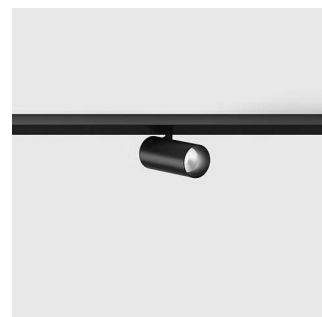

07.3270.5.930.BK



07.3270.5.930.BR



07.3270.5.930.CR

