

Specification

Indirect Lighting

Direct Lighting

Wall Wash



Wall Washing



SKYLINE

Design principles

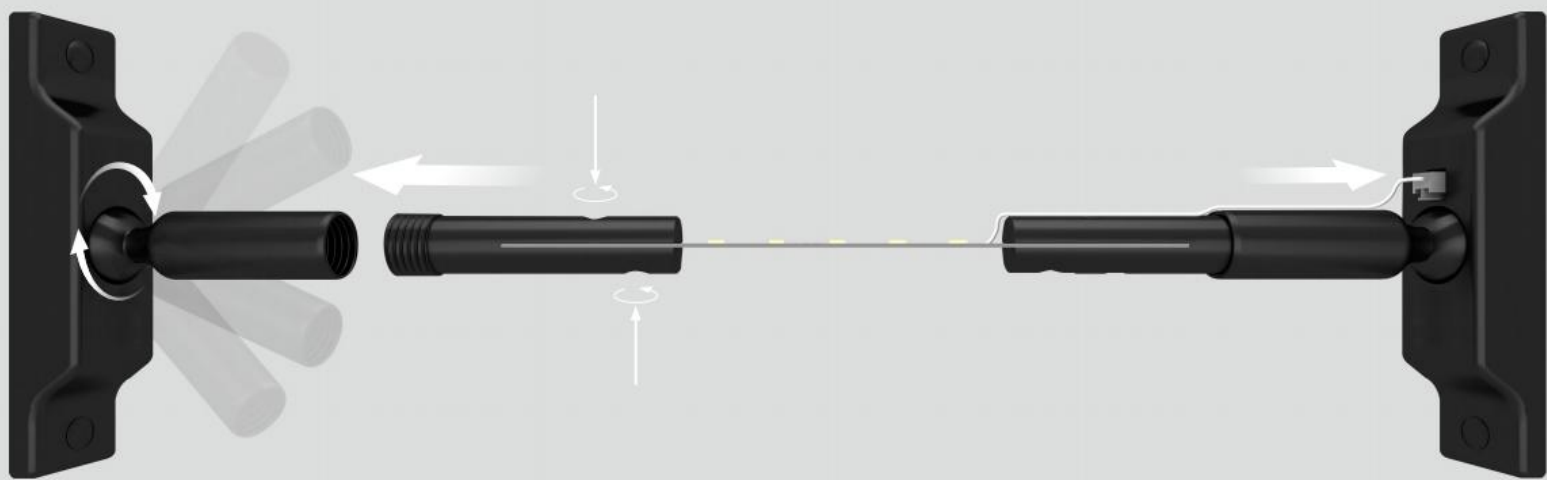

Application Guidelines

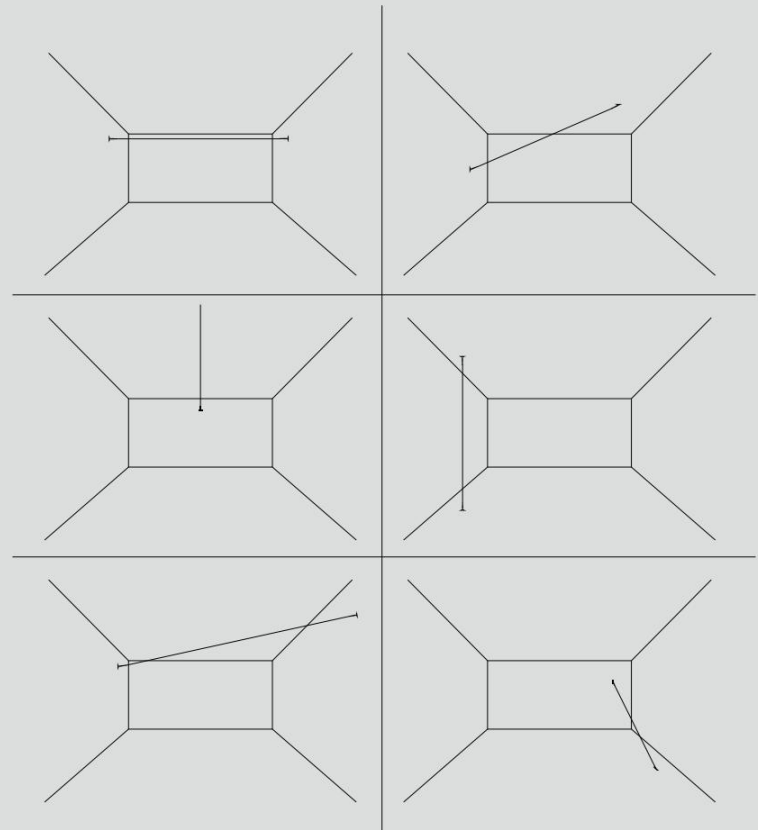
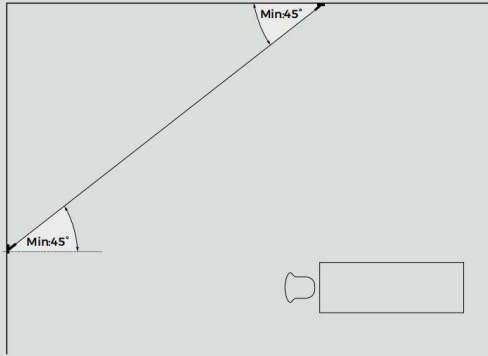
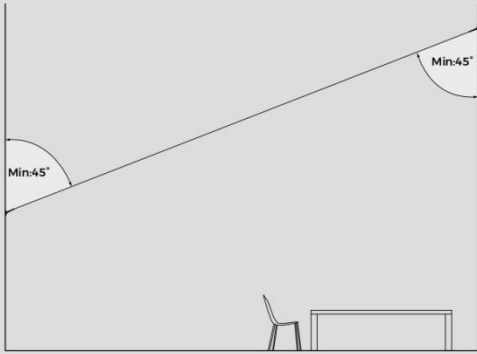

Installation guidelines

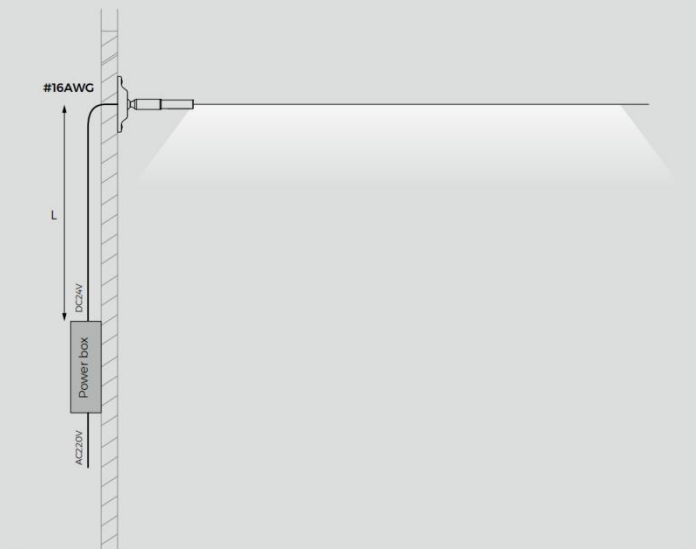
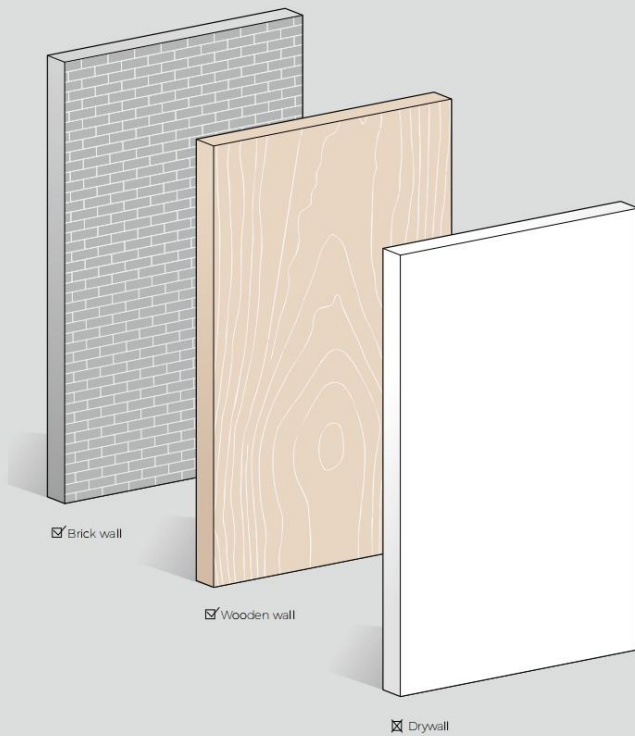





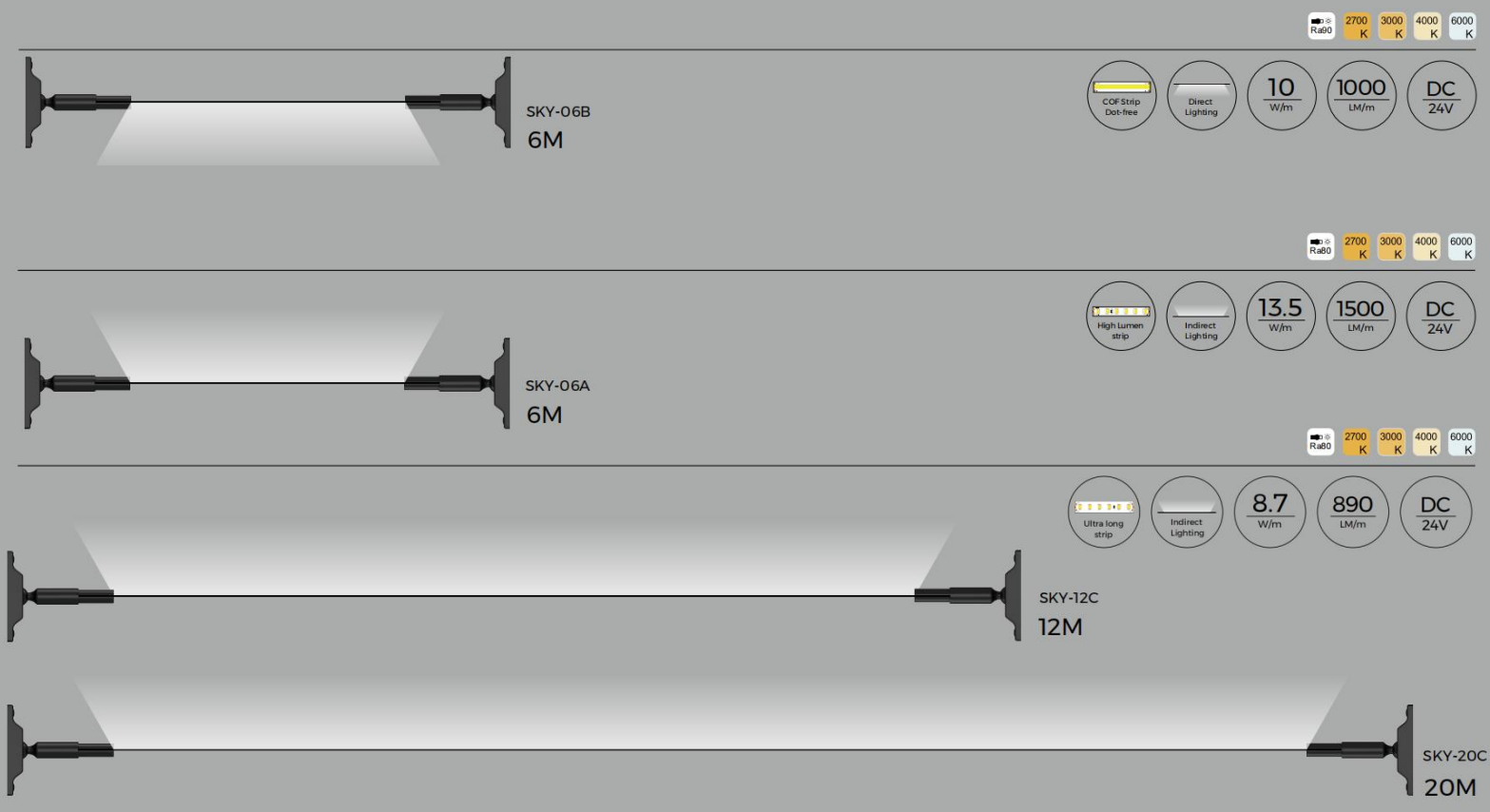



- SKY-06A: Lmax=9M; 13.5W/m; DC24V
- SKY-06B: Lmax=9M; 10W/m; DC24V
- SKY-12C: Lmax=7M; 8.7W/m; DC24V
- SKY-20C: Lmax=5M; 8.7W/m; DC24V

*Please calculate the required power according to the actual length

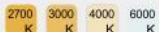
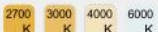
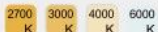

Parameters

Model	SKY-06B	SKY-06A	SKY-12C	SKY-20C
Length	6M	6M	12M	20M
Lighting source				
Cutting Unit	29.4mm	50mm	50mm	50mm
Input voltage	DC24V	DC24V	DC24V	DC24V
CCT				
CRI	>90	>90	>90	>90
Typ. power	10W/m	13.5W/m	8.7W/m	8.7W/m
Lumens	1000LM/m	1320LM/m	890LM/m	890LM/m
Color				

Optical & electronic data

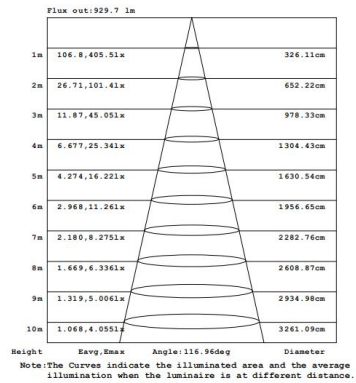
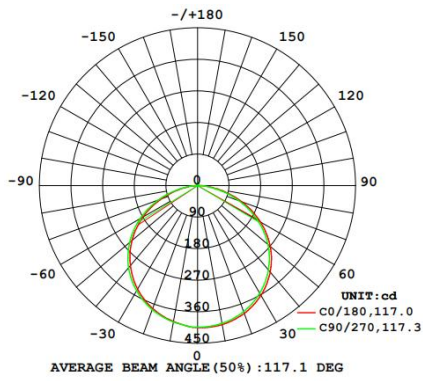

A

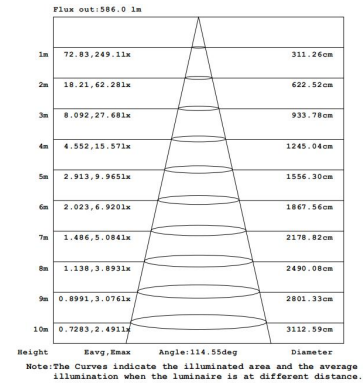
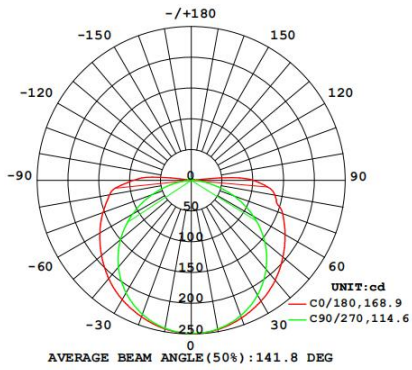

B

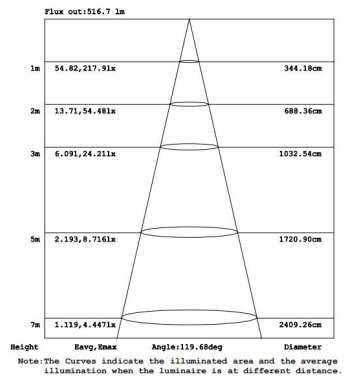
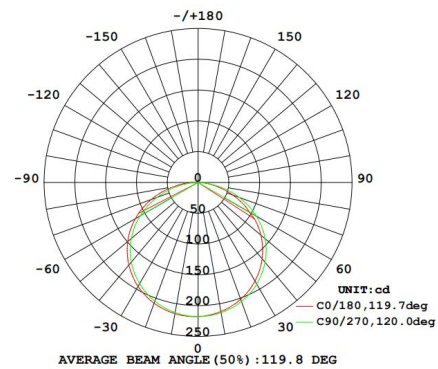

C

Dimension(mm)

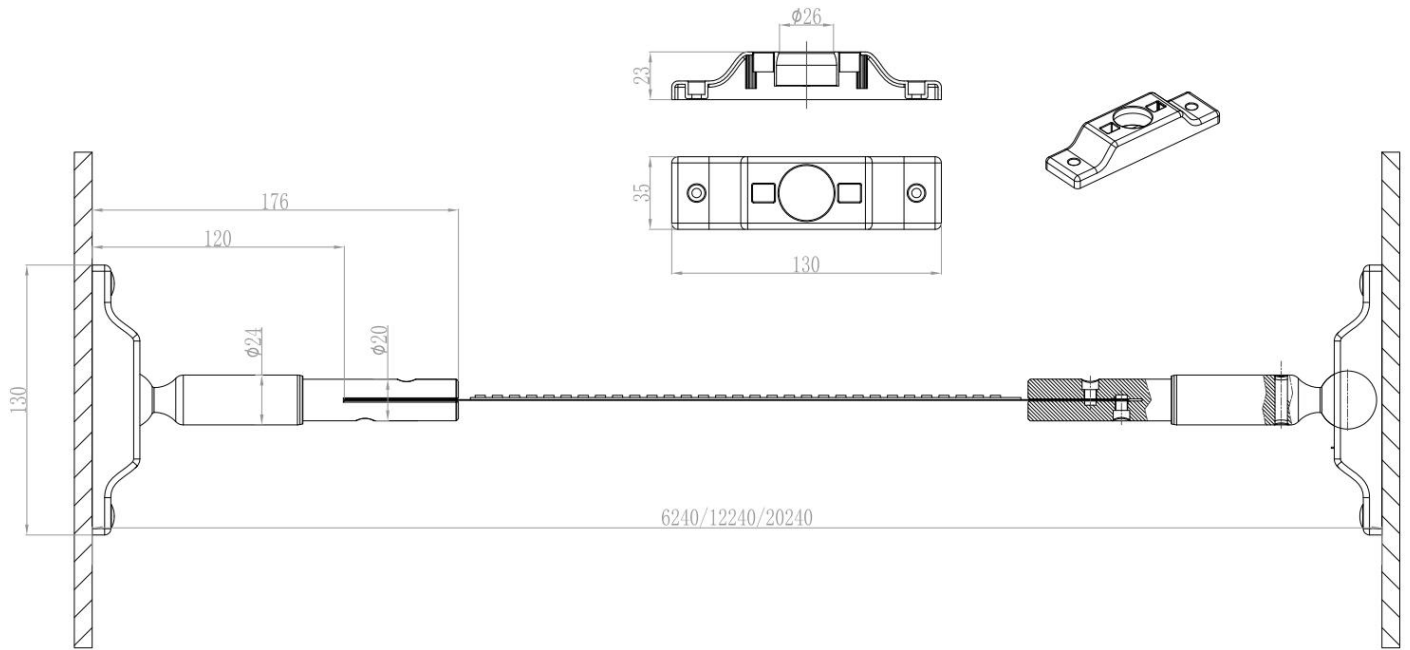

JustLight LT, UAB
Panerių g. 45B-9, Vilnius
+370 655 29065
apsvietimas@justlight.lt
www.justlight.lt