

Neon Specification

2020



【Features】

Light source: Adopting dedicated and outdoor-specific LED, stronger reliability for outdoor application; Finished product ANSI SDCM≤5;

• **Structure:** New anti-tension structure, Integrated anti-tension silicone extrusion process, against internal stress and external tension;

Double-layer circuit conductive, double power supply guarantee, broken boards without power cut;

• **DMX Chip model and pixel count:** white light/RGB/RGBW: UCS512H4LB,12 Pixels/m;

• **Product applications:** outdoor illumination, architectural facade lighting; IP67

• **Working/storage temperature(White/monochromatic light):** Ta: -40~60°C / 0~60°C

Symphony working/storage temperature(DMX/RGB/RGBW): Ta: -40~50°C / 0°C~60°C

• White with 7 years warranty or working life =84000H,whichever

comes first;RGB/RGBW/RGBM/RGBWM/White(DMX) with warranty 5 years or working



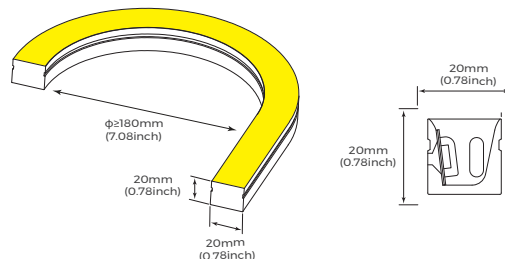







life=60000H,whichever comes first.



【Basic Parameters】

Model	CCT/Color	Color range	CRI	Input voltage (V)	Rated current (A/m)	Rated power (w/m)	Maximum power (w/m)	Lumens (LM/m)	Standard Length	Cutting Unit
2020- 9XX24 CSW025CCXXXX -GV10-ENP-ESD	2700 K	2600-2830K	>90	24V	0.42 (0.13A/ft)	10 (3.05W/ft)	11 (3.35W/ft)	574(175/ft)	10000mm (32.8ft)	16LED /50mm
	3000 K	2920-3170K						619(189/ft)		
	4000 K	3770-4220K						734(224/ft)		
2020- 9XX48 CSW025CCXXXX -GV10-ENP-ESD	2700 K	2600-2830K	>90	48V	0.21 (0.06A/ft)	10 (3.05W/ft)	11 (3.35W/ft)	499(152/ft)	20000mm (65.6ft)	32LED /100mm
	3000 K	2920-3170K						549(167/ft)		
	4000 K	3770-4220K						602(184/ft)		
2020- 0RGB24 CSW025CCXXXX -CV10-ENP-ESD	RGB	620-625nm	/	/	0.5 (0.15A/ft)	12 (3.65W/ft)	13.2 (4.02W/ft)	/	5000mm (16.4ft)	6LED /50mm
	R	515-520nm	/	/						
	G	455-460nm	/	/						
2020- 0RGBXW24 CSW025CCXXXX -GV10-ENP-ESD	RGBW	W-2700K RGB+(2550-2800K)	>90	24V	0.5 (0.15A/ft)	12 (3.65W/ft)	13.2 (4.02W/ft)	123(38/ft)	5000mm (16.4ft)	7LED /83.3mm
	RGBW	W-3000K RGB+(2800-3200K) /						141(43/ft)		
	RGBW	W-4000K RGB+(3900-4350K)						137(42/ft)		
2020- 0RGBM24 CSW025CCXXXX -GV10-ENP-ESD (DMX512-RGB)	RGB	620-625nm	>90	24V	0.6 (0.18/ft)	13.5 (4.12W/ft)	14.8 (4.51W/ft)	/	5000mm (16.4ft)	7LED/83.3mm DMX-1C:(UCS512H4LB) 12Pixels/m
	R	515-520nm								
	G	455-460nm								

【Basic Parameters】

Model	CCT/Color	Color range	CRI	Input voltage (V)	Rated current (A/m)	Rated power (w/m)	Maximum power (w/m)	Lumens (LM/m)	Standard Length	Cutting Unit
2020-0RGBXWM 24CDW025CCXXX -GV10-ENP-ESD (DMX512-RGBW)	 W-2700K  W-3000K  W-4000K	RGB+(2550-2800K) RGB+(2800-3250K) RGB+(3900-4350K)	>90	24V	0.69 (0.21A/ft)	16.5 (5.03W/ft)	18.1 (5.52W/ft)	123(38/ft) 141(43/ft) 137(42/ft)	5000mm (16.4ft)	7LED/83.3mm DMX-IC:(UCSS12H4LB) 12Pixels/m
2020- 9XWM24 CDW025CCXXX -GV10-ENP-ESD (DMX512-White)	 2700K  3000K  4000K	2550-2800K 2800-3200K 3900-4350K	>90	24V	0.56 (0.17A/ft)	13.5 (4.12W/ft)	14.8 (4.51W/ft)	442(135/ft) 570(174/ft) 595(181/ft)	5000mm (16.4ft)	7LED/83.3mm DMX-IC:(UCSS12H4LB) 12Pixels/m
2020L- 9XX24 CSW025CCXXX -GV10-ENP-ESD	 2700K  3000K  4000K	2600-2830K 2920-3170K 3770-4220K	>90	24V	0.42 (0.13A/ft)	10 (3.05W/ft)	11 (3.35W/ft)		10000mm (32.8ft)	16LED /50mm
2020- 0X24 CSW025CCXXX -GV10-ENP-ESD	 G 515-525nm  B 450-460nm	/	/	24V	0.42 (0.12A/ft)	10 (3.05W/ft)	11 (3.35W/ft)	/	10000mm (32.8ft)	16LED /50mm

Note:

1. The above parameters are tested based on 1m/3.28ft standard products;
2. The luminous flux is allowed to have an error range of -15%~+∞;
3. The above parameters are typical values;

【Light Distribution】

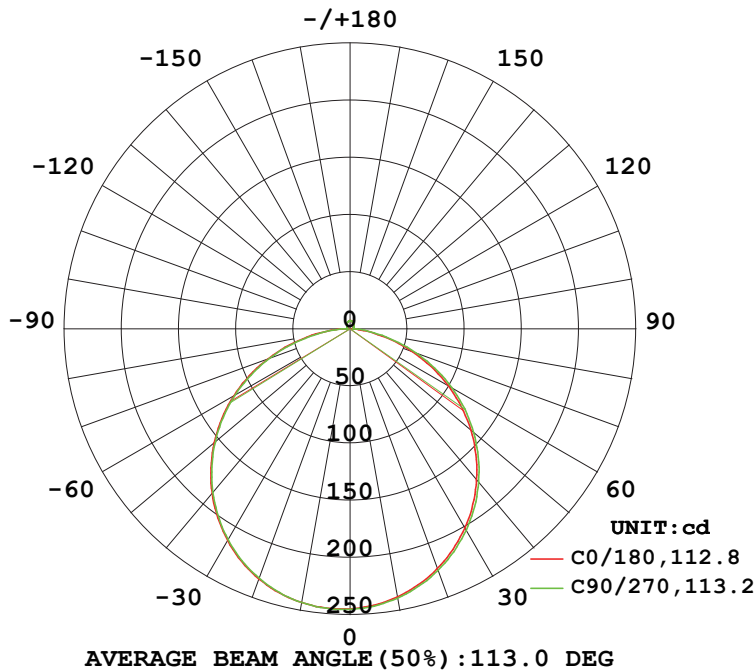

Light distribution

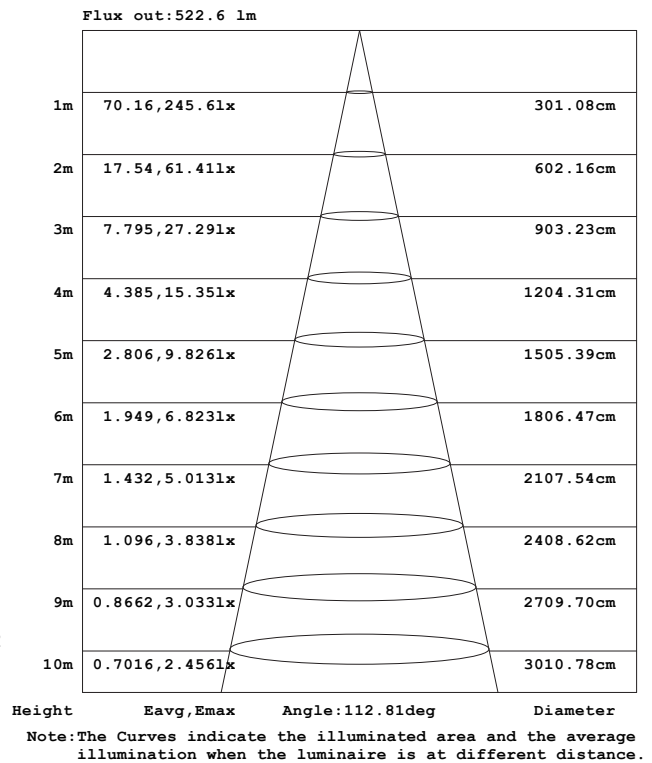

Effective average illuminance

Note: The above data is based on 24V monochrome 4000K color temperature. If you need other models of IES files, please consult with the sales staff.

[Product mechanical parameters]

• IP67 molded end cap (ENP)

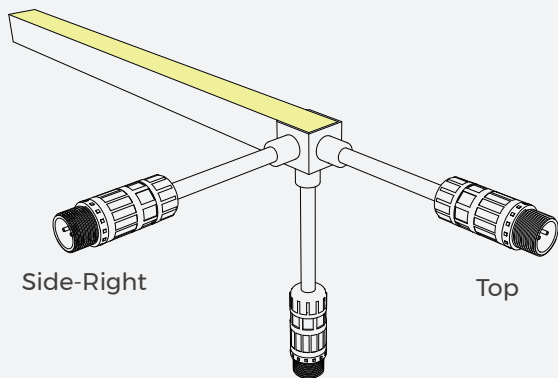

Side-Right

Top

Bottom

(about 2 cm dark)

• Bottom

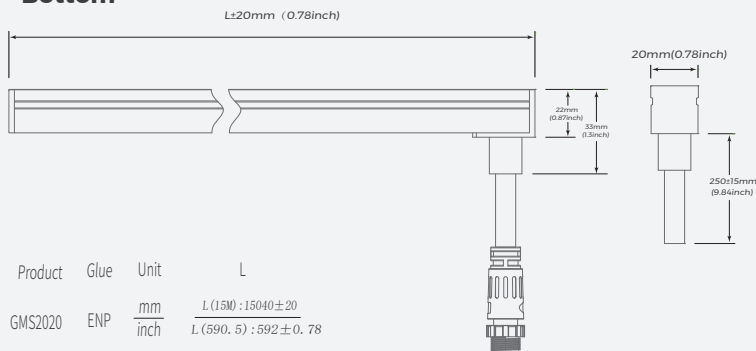

Product	Glue	Unit	L
GMS2020	ENP	$\frac{\text{mm}}{\text{inch}}$	$\frac{L(15M): 15040 \pm 20}{L(590.5): 592 \pm 0.78}$

• Side-Right

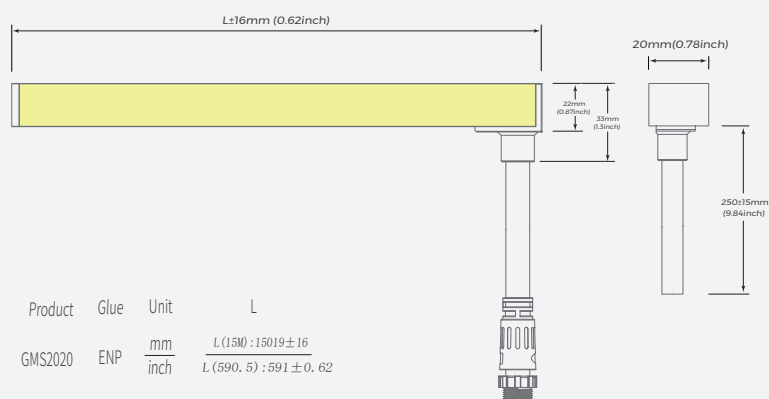





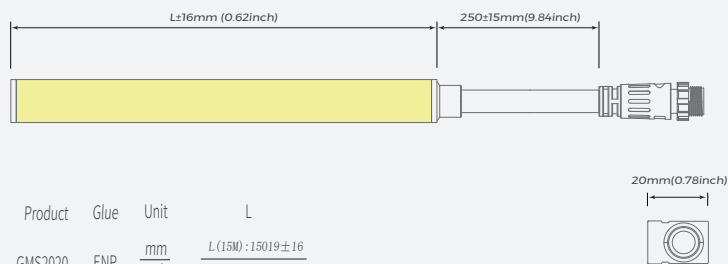





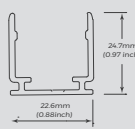

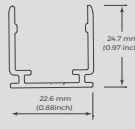
Product	Glue	Unit	L
GMS2020	ENP	$\frac{\text{mm}}{\text{inch}}$	$\frac{L(15M): 15019 \pm 16}{L(590.5): 591 \pm 0.62}$

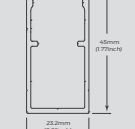
• Top

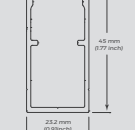



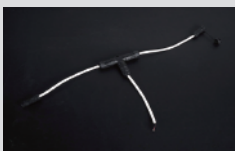



Product	Glue	Unit	L
GMS2020	ENP	$\frac{\text{mm}}{\text{inch}}$	$\frac{L(15M): 15019 \pm 16}{L(590.5): 591 \pm 0.62}$





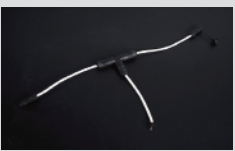
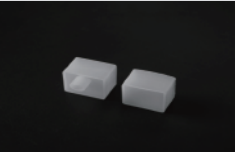

[Accessory information]

Name	describe	Accessories Picture	Section size	Order model	quantity /case (PCS)	net weight (kg)	Per box net weight (kg)	Gross weight (kg)	Box Size (mm)	Remark
Aluminium carrier	Flat mounting aluminum groove			AS-GMS/T2020A-1000	32	0.25	8.192	10.142	1180*135*130	Size: L1000*W22.6* H24.7mm with screw
Aluminum clip	Flat mounting clip			AS-GMS/T2020A-25	640	0.006	5.12	5.42	250*250*150	Size: L25*W22.6* H24.7mm with screw
Aluminium carrier	Aluminum groove with reserved wire outlet			AS-GMS/T2020A1-1000	16	0.495	8.016	9.966	1180*135*130	Size: L1000*W23.2* H45mm with screw
Aluminum clip	clip with reserved wire outlet			AS-GMS/T2020A1-25	360	0.0117	4.932	5.232	250*250*150	Size: L25*W23.2* H45mm with screw
glue	588G Acid glue		/	AS-PG-0002	150	0.014	2.1	2.4	250*250*150	10ml/pcs
Wire	2P DC wire (Male)		/	AS-FC-0009 (0.25M) AS-FC-0010 (0.5M) AS-FC-0011 (2M)	200 200 50	0.0193 0.031 0.1012	3.86 6.2 5.06	4.16 6.5 5.36	250*250*150	suitable for monochromatic led strip Wire lengths are optional: 0.25M/0.5M/2M
Wire	2P DC wire (Female)		/	AS-FC-0012 (0.25M) AS-FC-0013 (0.5M) AS-FC-0014 (2M)	200 200 50	0.0212 0.0329 0.1031	4.24 6.58 5.155	4.54 6.88 5.48	250*250*150	suitable for monochromatic led strip Wire lengths are optional: 0.25M/0.5M/2M
Wire	2P T-Connection Wire		/	AS-FC-0027	20	0.0652	1.304	1.604	250*250*150	suitable for monochromatic led strip Wire length 150mm
Wire	4P DC wire (Male)		/	AS-FC-0015 (0.25M) AS-FC-0016 (0.5M) AS-FC-0017 (2M)	200 200 50	0.0196 0.0316 0.1036	3.92 6.32 5.18	4.22 6.62 5.48	250*250*150	suitable for RGB led strip Wire lengths are optional: 0.25M/0.5M/2M

[Accessory information]

Name	describe	Accessories Picture	Section size	Order model	quantity /case (PCS)	net weight (kg)	Per box net weight (kg)	Gross weight (kg)	Box Size (mm)	Remark
Wire	4P DC wire (Female)		/	AS-FC-0018 (0.25M) AS-FC-0019(0.5M) AS-FC-0020(2M)	200 200 50	0.0215 0.0354 0.1188	4.3 7.08 5.94	4.6 7.38 6.24	250*250*150	suitable for RGB led strip Wire lengths are optional: 0.25M/0.5M/2M
Wire	4P T-Connection Wire		/	AS-FC-0028	20	0.0675	1.35	1.65	250*250*150	suitable for RGB led strip Wire length 150mm
Wire	5P DC wire (Male)		/	AS-FC-0021 (0.25M) AS-FC-0022(0.5M) AS-FC-0023(2M)	200 200 50	0.0196 0.0316 0.1036	3.92 6.32 5.18	4.22 6.62 5.48	250*250*150	suitable for RGBW/DMX led strip Wire lengths are optional: 0.25M/0.5M/2M
Wire	5P DC wire (Female)		/	AS-FC-0024 (0.25M) AS-FC-0025(0.5M) AS-FC-0026(2M)	200 200 50	0.0215 0.0354 0.1188	4.3 7.08 5.94	4.6 7.38 6.24	250*250*150	suitable for RGBW/DMX led strip Wire lengths are optional: 0.25M/0.5M/2M
Wire	5P T-Connection Wire		/	AS-FC-0029	20	0.0694	1.388	1.688	250*250*150	suitable for RGBW led strip Wire length 150mm
Wire	5P T-Connection Wire		/	AS-FC-0030	20	0.0698	1.396	1.696	250*250*150	suitable for DMX led strip Wire length 150mm
Plug	Silicone Plug Set. Includes plug and plug end (Top)		/	AS-GMS2020GH0-EC	200	0.0048	0.976	1.276	250*250*150	/
Plug	Silicone Plug Set. Includes plug and plug end (Side)		/	AS-GMS2020GS0-EC	200	0.0055	1.114	1.414	250*250*150	/

[Product control system solutions]

Product Picture	Product Name	Product Model	Order model	specification	Applicable product
	Monochrome remote	CK1-GBA	402-02-000000-00001	output signal: RF Working voltage: 3VDC(CR2032) Remote control distance: 30m Working temperature: Ta:0-30 C -0+55 C	Monochrome light strip (Use with CR1-GBA)
	Monotone light controller	CR1-GBA	402-01-000000-00001	Input voltage: DC12-48V Output current: 15A@12V/24V,10A@36V/48V Output Power: Max 180W@12V/Max 360W @24V/Max 360W@36V/Max 480W@48V Working temperature: -30 C— +55 C	Monochrome light strip (Use with CR1-GBA)
	RGB/RGBW remote control	CK4-GBA	402-02-000000-00003	output signal: RF Working voltage: 3VDC(CR2032) Remote control distance: 30m Working temperature: Ta:0-30 C -0+55 C	RGB/RGBW light strip (Use with CR3-GBA)
	RGB controller	CR3-GBA	402-01-000000-00003	Input voltage: DC12-48V Output current: 18A Output Power: Max 216W@12V/Max 432W @24V/Max 648W@36V/Max 864W@48V Working temperature: -30 C— +55 C	RGB light strip (Use with CK4-GBA)
	RGBW controller	CR4-GBA	402-01-000000-00004	Input voltage: DC12-48V Output current: 20A Output Power: Max 240W@12V/Max 480W@24V Max 720W@36V/Max 960W@48V Working temperature: -30 C -0+55 C	RGBW light strip (Use with CK4-GBA)
	Symphony Controller	K-8000C	23-01-00-0050	Power supply: DC 5V-24V input Power consumption: 5W Working temperature: Ta:0-20 C -0+85 C	DMX/SPI magic lights with universal

[Product Wiring Schematic]

