

Neon Specification

MLR25

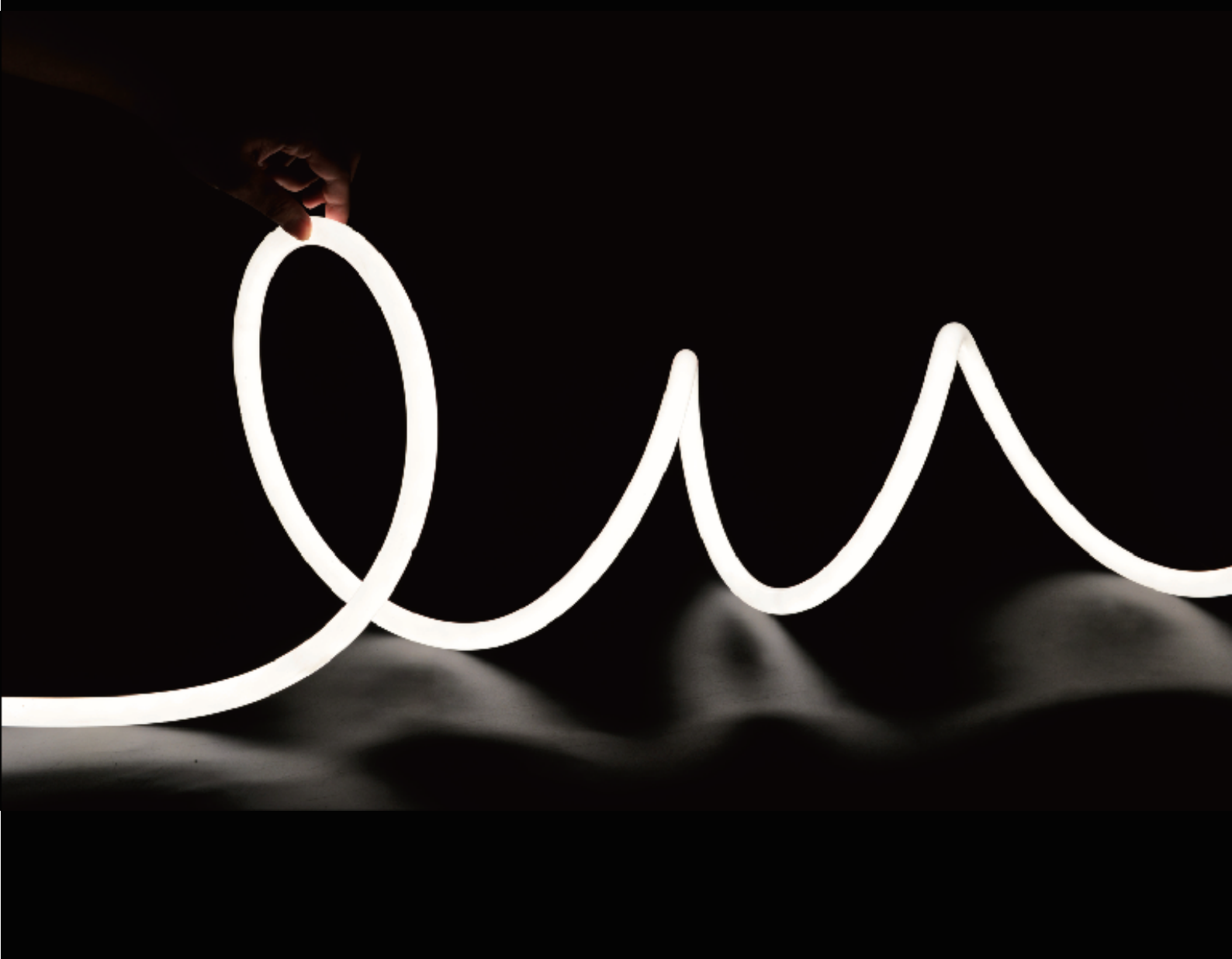
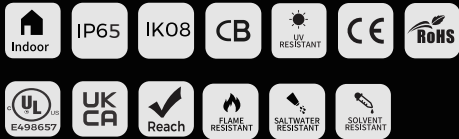

【Features】

- Light source: high luminous efficiency LED lamp beads, LM80 test certification;
- Process material: high light transmittance, high purity silica gel material, IP65 protection level;
- Optical design: unique optical light distribution structure design, 360° light output uniformly without shadows;
- Appearance design: skin-friendly surface treatment, comfortable touch, good flexibility, and simple shape;
- Product certification: UL, CE, ROHS, UKCA, CB;
- Environmental characteristics: salt solution resistance, acid and alkali corrosion resistance, flame retardant resistance, UV resistance;
- Working/storage temperature: Ta: -25~55°C / 0°C~60°C;
Symphony working/storage temperature: Ta: -20~40°C / 0°C~60°C;
- SPI chip mode and pixel count: R/G/B/RGB: WS2815,90Pixels/m;
- Product application: office lighting, decorative lighting, artistic lighting, modeling contrast;
- White/G/B/CCT/RGB with 3 years warranty or working life =36000H,whichever comes first;SPI with warranty 2 years or workinglife=20000H,whichever comes first.

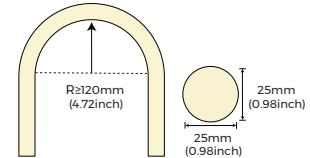
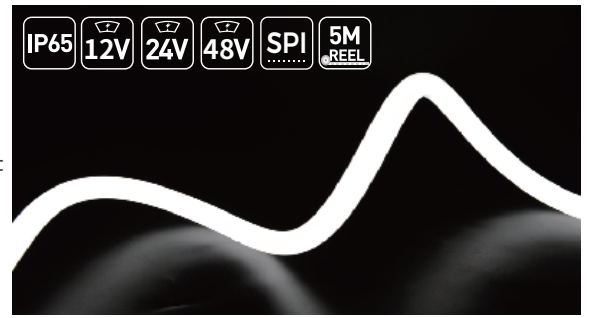

【Basic Parameters】

Model	CCT/colors	CRI	Input voltage (V)	Rated current (A/m)	Rated power (w/m)	Maximum power (w/m)	Lumens (LM/m)	Standard Length	Remark
MLR25-9XX 24CSN050BCXXX-ESD	2300K	>90	24V	0.6 (0.18A/ft)	14.4 (4.39W/ft)	16 (4.88W/ft)	750(225/ft)	1000mm (3.28ft)	Arbitrary cutting 4LED/11.97mm
	2700K						950(285/ft)		
	3000K						950(285/ft)		
	3500K						950(285/ft)		
	4000K						950(285/ft)		
MLR25-0X 24CSN050BCXXX-ESD	G 620-630nm	/	24V	0.42 (0.13A/ft)	10 (3.05W/ft)	11 (3.35W/ft)	/	1000mm (3.28ft)	No cutting 14LED/41.67mm
	B 465-470nm	/					/		
MLR25-ORGB 24CSN050BCXXX-ESD	RGB	/	24V	0.6 (0.18A/ft)	14.4 (4.39W/ft)	16.5 (5.03W/ft)	510(155/ft)	2500mm (8.2ft)	No cutting 14LED/50mm
MLR25-9LWNW 24CSN050BCXXX-ESD	2300K~4000K	>90	24V	0.6 (0.18A/ft)	14.4 (4.39W/ft)	16 (4.88W/ft)	950(285/ft)	5000mm (16.4ft)	No cutting 24LED/31.25mm
MLR25-ORGBXW 24CSN050BC0500-ESD	RGB-2300K	/	24V	0.72 (0.22A/ft)	17.2 (5.21W/ft)	19.8 (6W/ft)	/	/	No cutting 24LED/62.5mm
	RGB-2700K								
	RGB-3200K								
	RGB-4500K								
MLR25-9XX 48CSN050BC2000-ESD	2300K	>90	48V	0.26 (0.08A/ft)	12.5 (3.81W/ft)	13.7 (4.18W/ft)	875(265/ft)	20000mm (65.6ft)	No cutting 28LED/83.33mm
	2700K						1000(303/ft)		
	3000K						1000(303/ft)		
	4000K						1060(321/ft)		
MLR25-ORGBXW 48CSN050BC1000-ESD	RGB-(2300K/2700K/ 3200K/4500K)	/	48V	0.36 (0.11A/ft)	17.2 (5.21W/ft)	19.8 (6W/ft)	/	10000mm (32.8ft)	No cutting 48LED/125mm
MLR25-ORGBX 12CSN050BC0500-ESD	R	/	12V	1.8 (0.55A/ft)	21.6 (6.5W/ft)	23.8 (7.2W/ft)	/	5000mm (16.3ft)	Arbitrary cutting 2LED/11.11mm IC:(WS2815) 90Pixels/m
	G						/		
	B						/		
	RGB						302(92.1/ft)		

Note:

1. The above parameters are tested based on 1m (3.28ft) standard products;
2. The luminous flux is allowed to have an error range of ±15%;
3. The above parameters are typical values;

[Light Distribution]

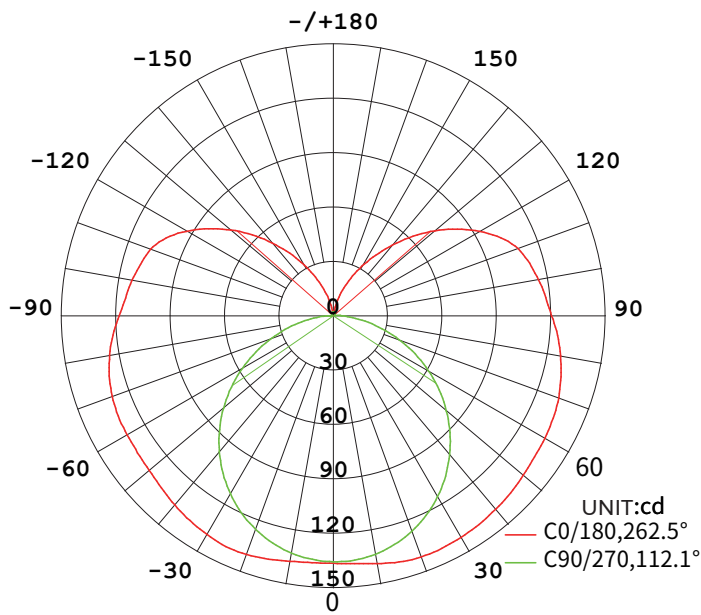

AVERAGE BEAM ANGLE(50%):187.3 DEG

Light distribution

Flux out:630.0 lm

Height	Eavg,Emax	Angle:179.00deg	Diameter
1m	0.0000, 136.61x		22917.70cm
2m	0.0000, 34.151x		45835.40cm
3m	0.0000, 15.181x		68753.09cm
4m	0.0000, 8.5371x		91670.79cm
5m	0.0000, 5.4641x		114588.49cm
6m	0.0000, 3.7941x		137506.19cm
7m	0.0000, 2.7881x		160423.89cm
8m	0.0000, 2.1341x		183341.59cm
9m	0.0000, 1.6861x		206259.28cm
10m	0.0000, 1.3661x		229176.98cm

Note:The Curves indicate the illuminated area and the average illumination when the luminaire is at different distance.

Effective average illuminance

Note: The above data is based on 24V monochrome 4000K color temperature. If you need other models of IES files, please download the corresponding models from the IES database.

[Product mechanical parameters]

• IP65 Silicone Plug -Top Outlet

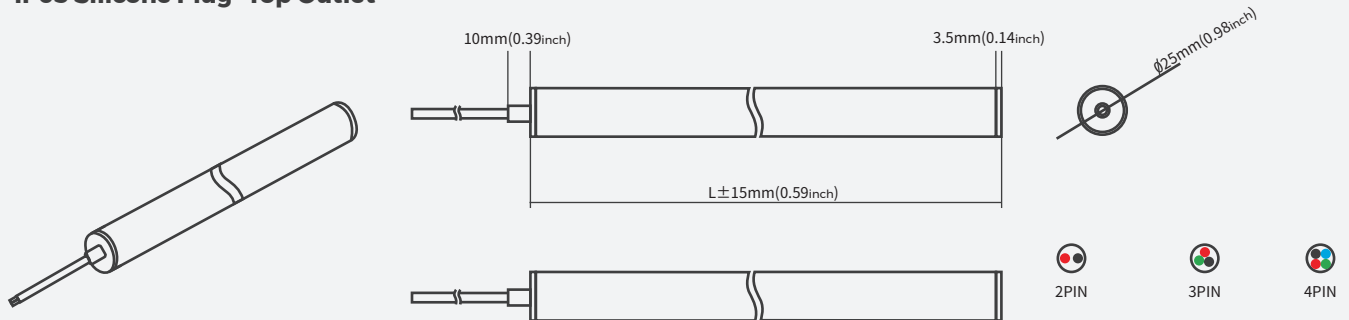

• IP65 Silicone Plug -Side outlet

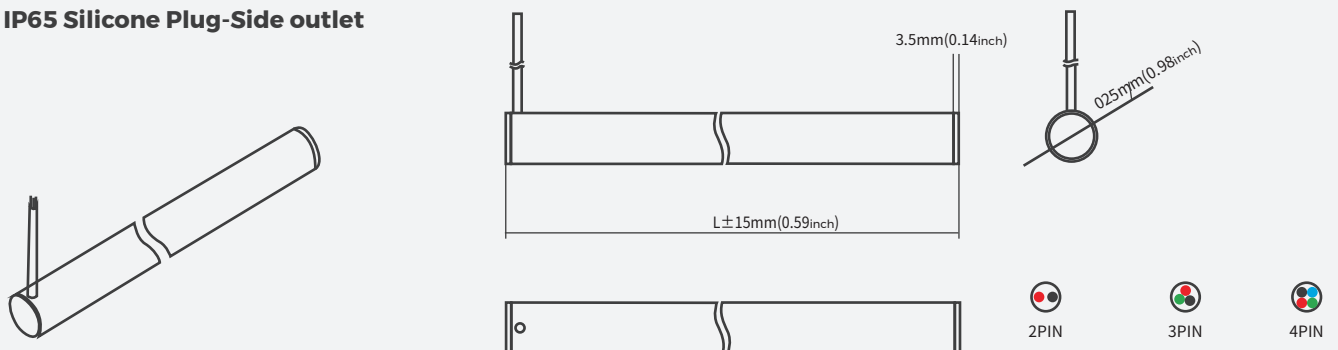









[Accessory information]

Installation schematic	Accessories Picture	name	Order model	quantity/ case	net weight (kg)	Per box net weight (kg)	Gross weight (kg)	Gross weight (mm)	Remark
/		NNR25 ceiling Fixed installation components	AS-NNR25PI-25	100	0.01	1.00	1.20	250*250*150	Size:L25*W51.6*H27.8mm . With screws: 3pcs/1M;5pcs/2.5M;8pcs/5M
		Vertical hanging side outlet Install accessory kit (1m)	AS-NNR25VHSI- 1000	16	0.28	4.40	5.29	1285*160*160	NNR25-XXXXBC0100 Round tube:1M;Wire rope:2M For white, monochrome light only
		Vertical hanging side outlet Install accessory kit (2.5m)	AS-NNR25VHSI- 2500	16	0.52	8.40	10.12	2580*165*165	NNR25-XXXXBC0250 Round tube:2.5M;Wire rope:2M For white, monochrome light only
		Hang the top vertically Outlet installation accessory kit (1m)	AS-NNR25VHD1- 1000	16	0.31	4.90	5.79	1285*160*160	NNR25-XXXXBC0100 Round tube:1M;Wire rope:2M For white, monochrome light only
		Vertical hanging from the top Install accessory kit (2.5m)	AS-NNR25VHD1- 2500	16	0.55	8.83	10.55	2580*165*165	NNR25-XXXXBC0250; Round tube:2.5M;Wire rope:2M For white, monochrome light only
		Single-ended vertical ceiling Install accessory kit (1m)	AS-NNR25VCCI- 1000	16	0.23	3.63	4.52	1285*160*160	NNR25-XXXXBC0100 Round tube:1M;
		Single-ended vertical ceiling Install accessory kit (2.5m)	AS-NNR25VCCI- 2500	16	0.47	7.57	9.29	2580*165*165	NNR25-XXXXBC0250 Round tube:2.5M;
		Horizontal ceiling installation components	AS-NNR25LCX- 1000	15	0.08	1.20	1.80	1180*125*115	NNR25-XXXXBC0100 NNR25-XXXXBC0500 PC slot:1M;
		Horizontal hoisting Install components (38mm)	AS-NNR25LHX- 0038	96	0.07	6.75	7.35	365*365*190	NNR25-XXXXBC0100 NNR25-XXXXBC0250 NNR25-XXXXBC0500 Round tube:38mm; Wire rope 2pcs, L:2M; Recommended dosage:1PCS/0.5M
		Horizontal hoisting Install components (1M)	AS-NNR25LHX- 1000	16	0.18	2.88	3.48	1180*125*115	NNR25-XXXXBC0100 Round tubeL:1020mm; Wire rope 2pcs, L:2M;







[Accessory information]

Installation schematic	name	Accessories Picture	Order model	quantity/	net	Per box	Gross	Gross	Remark
				case	weight	net	weight	weight	
				(PCS)	(kg)	(kg)	(kg)	(mm)	
	Horizontal hoisting Install components (2.5M)		AS-NNR25LHX-2500	16	0.33	5.28	6.28	2580*165*165	Round tubel.:2520mm; Wire rope 2pcs 2pcs, L:2M;
	Double-ended vertical ceiling Kits		AS-NNR25VCC1-XX-2	48	0.13	6.05	6.65	365*365*190	NNR25-XXXXBC0100 NNR25-XXXXBC0250 NNR25-XXXXBC0500
	Can be spliced Install components		AS-NNR25DHS-XX	48	0.05	2.30	2.91	365*365*190	NNR25-XXXXBC0100 NNR25-XXXXBC0250 NNR25-XXXXBC0500
	Concealed Install components		AS-NNR25DCX-XX	480	0.01	2.40	3.13	365*365*190	NNR25-XXXXBC0100 NNR25-XXXXBC0250 NNR25-XXXXBC0500 Recommended dosage:1PCS/0.5M
	Can be shaped and hoisted Install components		AS-NNR25DHX-0038	15	0.20	3.00	3.62	415*250*230	NNR25-XXXXBC0100 NNR25-XXXXBC0250 NNR25-XXXXBC0500 Round tube L:38mm; Telescopic rodL:0.6M Recommended dosage:1PCS/0.5M
/	NNR25 Plug set		AS-NNR25GH0-EC	500	0.0004	0.20	1.00	250*250*150	top-out wire Suit to NNR25 white/ monochrome light/ CCT/RGB/RGBW
/	NNR25 Plug set		AS-NNR25GS0-EC	500	0.0004	0.20	1.00	250*250*150	side-out wire Suit to NNR25 white/ monochrome light/CCT/RGB
/	NNR25 Plug set		AS-NNR25GH1-EC	500	0.0004	0.20	1.00	250*250*150	top-out wire Suit to NNR25 SPI
/	NNR25 Plug set		AS-NNR25GS1-EC	500	0.0004	0.20	1.00	250*250*150	side-out wire Suit to NNR25 SPI/ RGBW
/	connectors		AS-FC-0001	512	0.018	9.216	10.2	365*365*190	Suitable for monochromatic light strip
/	connectors		AS-FC-0002	512	0.018	9.216	10.2	365*365*190	Suitable for CCT light strip
/	connectors		AS-FC-0003	512	0.018	9.216	10.2	365*365*190	Suitable for RGB light strips

[Accessory information]

name	describe	Accessories Picture	Section size	Order model	quantity/ case (PCS)	net weight (kg)	Per box net weight (kg)	Gross weight (kg)	Gross weight (mm)	Remark
/	woven material		/	AS-NNR25CCX S-B-3	13	0.3	3.9	4.9	410*410*260	Size: ø115*H28mm with screws
				AS-NNR25CCX M-B-3	13	0.44	5.72	6.72	410*410*260	Size: ø150*H28mm with screws
				AS-NNR25CCX L-B-3	13	0.6	7.8	8.8	410*410*260	Size: ø175*H28mm with screws
woven material	woven material		/	AS-NNR25C-053	48	0.07	3.36	4.34	365*365*190	Suitable for NNR25 strips Size:ø41*H53mm
woven material	woven material		/	AS-NNR25C-090	16	0.13	2.08	3.06	365*365*190	Suitable for NNR25 strips Size:ø41*H90mm
Trimless embedded accessory	NNR25 Trimless embedded accessory		/	AS-NNR25VTD -XX-2	36	0.11	3.96	4.96	410*410*260	Appearance size: φ62*20mm Mounting hole size: φ40mm
Embedded accessory	NNR25 Embedded accessory		/	AS-NNR25VRD -XX-2	36	0.18	6.48	7.48	410*410*260	Appearance size: φ64*20mm Mounting hole size: φ40mm
No dark areas accessory	NNR25 No dark areas accessory		/	AS-NNR25LHS -0080	48	0.07	3.36	3.96	365*365*190	Suit to NNR25/NNR25P /NNR25BLK (side out wire)
Glue	588G acidic glue		/	AS-PG-0002	150	0.014	2.1	2.4	250*250*150	10ml/pcs
Wire	2P PVC wire (0.5M)		/	AS-WS-0001	150	0.01541	2.31	2.61	250*250*150	Suitable for monochromatic light strips (Use the top-out line)
Wire	2P PVC wire (2M)			AS-WS-0002	125	0.0616	7.7	8	250*250*150	
Wire	4P PVC wire (0.5M)		/	AS-WS-0003	150	0.0194	2.91	3.21	250*250*150	Suitable for RGB strips (Use the top-out line)
Wire	4P PVC wire (2M)			AS-WS-0004	125	0.0776	9.7	10	250*250*150	

[Product control system solutions]

Product Image	product name	Product number	Order code	Product specifications	Applicable Products
	Monochrome remote	CK1-GBA	402-02-000000-00001	output signal:RF Working voltage:3VDC(CR2032) Remote control distance:30m Working temperature:Ta:0-30 °C-0+55 °C	Monochrome light strip (Use with CR1-GBA)
	Monotone light controller	CR1-GBA	402-01-000000-00001	Input voltage:DC12-48V Output current:15A@12V/24V,10A@36V/48V Output Power:Max 180W@12V/Max 360W @24V/Max 360W@36V/Max 480W@48V Working temperature:-30°C— +55°C	Monochrome light strip (Use with CR1-GBA)
	CCT remote control	CK2-GBA	402-02-000000-00002	output signal:RF Working voltage:3VDC(CR2032) Remote control distance:30m Working temperature:Ta:0-30 °C-0+55 °C	CCT light strip (Use with CR2-GBA)
	Color temperature controller	CR2-GBA	402-01-000000-00002	Input voltage:DC12-48V Output current:8A Output Power:Max 192W@12V/Max 284W @24V/Max 576W@36V/Max 768W@48V Working temperature:-30°C— +55°C	CCT light strip (Use with CK2-GBA)
	RGB/RGBW remote control	CK4-GBA	402-02-000000-00003	output signal:RF Working voltage:3VDC(CR2032) Remote control distance:30m Working temperature:Ta:0-30 °C-0+55 °C	RGB/RGBW light strip (Use with CR3-GBA)
	RGB controller	CR3-GBA	402-01-000000-00003	Input voltage:DC12-48V Output current:18A Output Power:Max 216W@12V/Max 432W @24V/Max 648W@36V/Max 864W@48V Working temperature:-30°C— +55°C	RGB light strip (Use with CK4-GBA)
	Symphony Controller	K-8000C	23-01-00-0050	Power supply:DC 5V-24V input Power consumption:5W Working temperature:Ta:0-20 °C-0+85 °C	DMX/SPI magic lights with universal