

# Infinite Curve 2 Series

# Infinite Curve 2

The COLORS infinite Curve2 system brings a brand new transformative experience to linear lighting through the sublimation from straight lines to curved lines and the transformation from two-dimensional to three-dimensional. By using the basic modules of straight and curved lines, various circular lamps, freely spliced curves, and freely interlaced combination shapes can be formed. Infinite possibilities, infinite imagination, flowing light freely shuttle along the walls of heaven and earth, giving rise to countless shapes and opening up new lighting perspectives.



# Product Type

35mm

50mm

70mm

Ceiling & Pendant

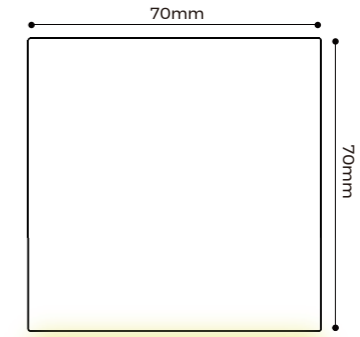
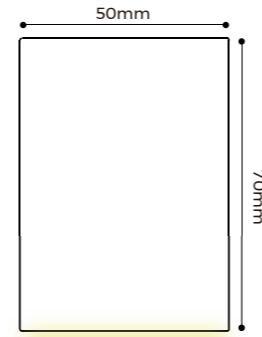
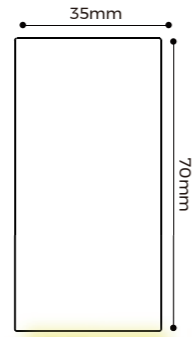

Ceiling & Pendant

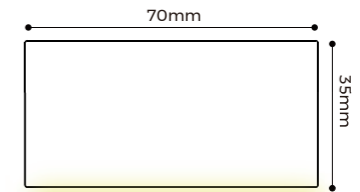
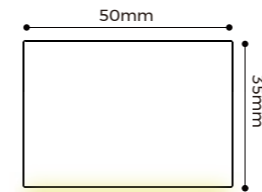
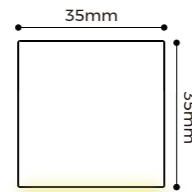

Recessed

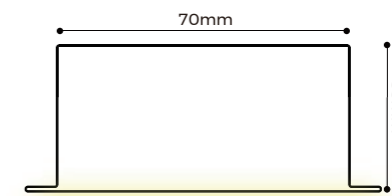
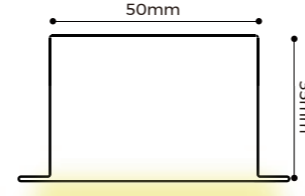
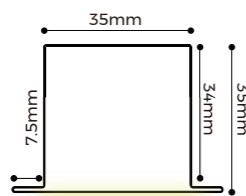

# Module Types

Connect straight pieces in various lengths with a range of curves in different diameters and angles.

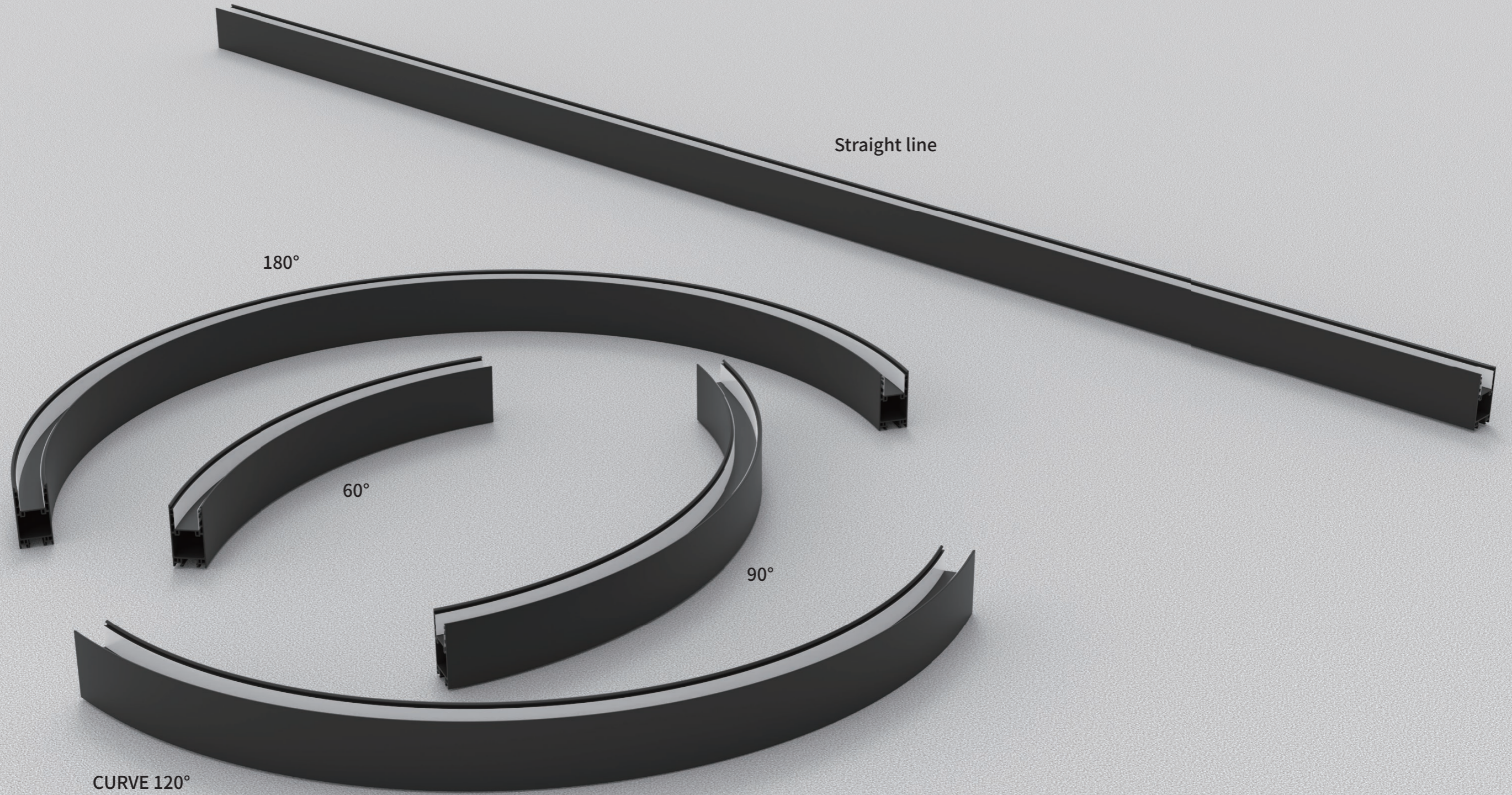

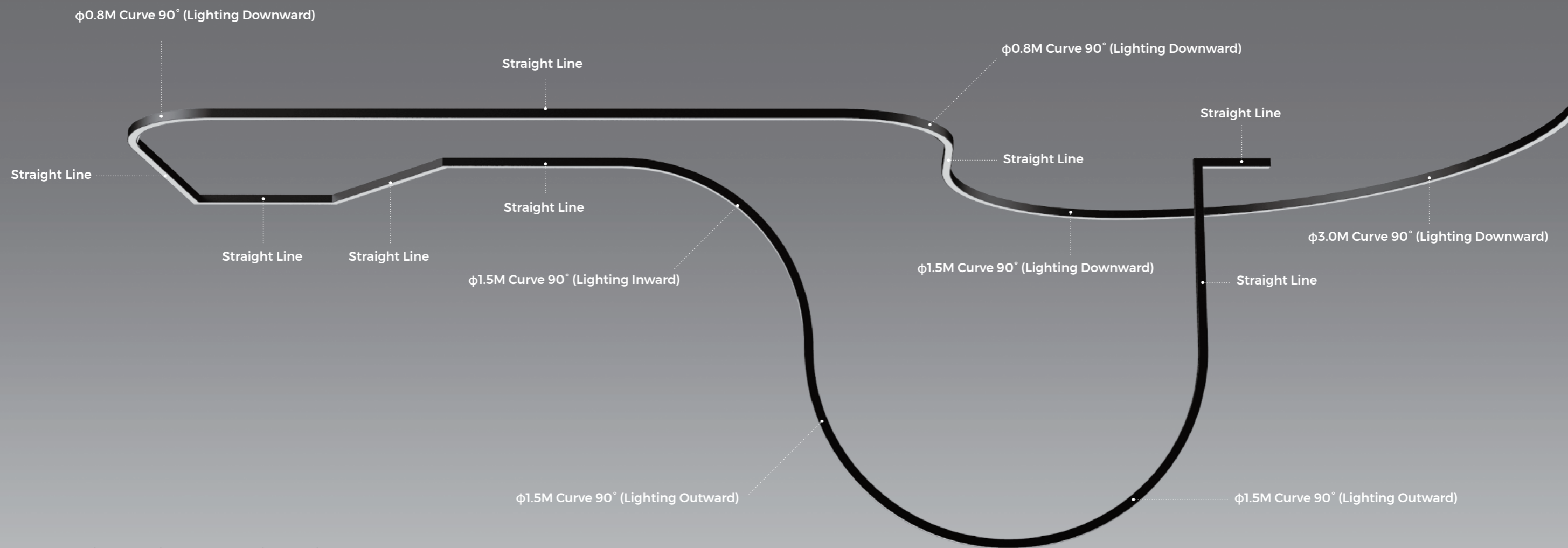

## Application Principle

Straight modules can be cut in different lengths and angles freely for application. Curve modules and straight modules can be interconnected with accessories for random interconnection and application. Through the modules of lighting inward/lighting outward, the 3D spacial application could be realized. Limitless possibilities lead to limitless applications and thousands of styles.

# 40% Higher In Lighting Efficiency

Compared With Our 1st Generation  
Curve System

High reflectance PET material  
Reflectance  $\geq 98\%$

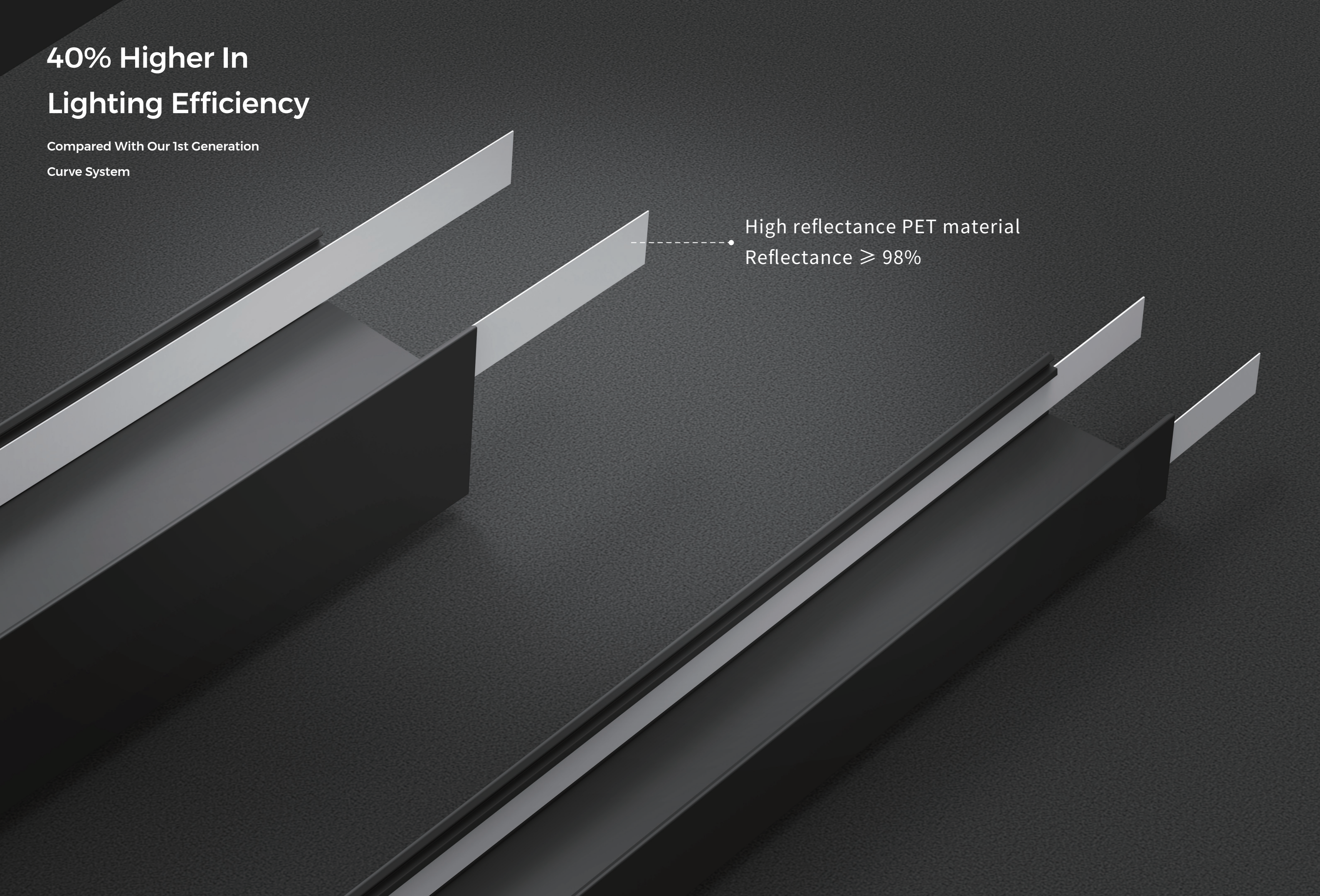
A 3D cutaway diagram of a lighting fixture, showing two different internal designs. The top design is a curved system, and the bottom design is a more complex, multi-layered system. A dashed line points from the text 'High reflectance PET material Reflectance ≥ 98%' to a specific layer in the bottom design. The background is dark grey.

# Arbitrary bending, twisting and flexible styling

(suitable for all basic modules)

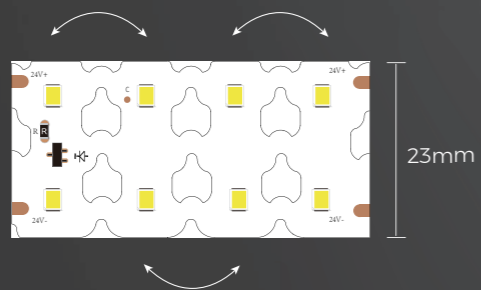

Horizontal bending:  $D_{min} \geq 1000mm$

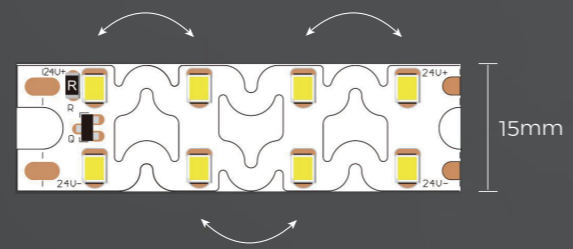

Bending angle:  $0^\circ < \theta < 10^\circ$   
Horizontal bending:  $D_{min} > 320mm$

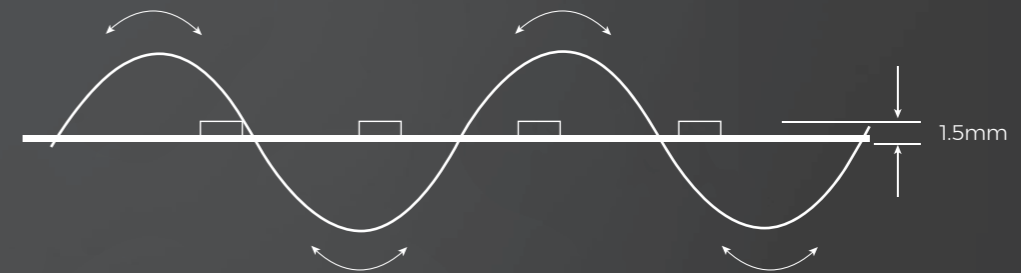

Vertical bending:  $R_{min} \leq 60mm$

# Flexible Diffuser

20M/roll flexible diffuser available for all  
modules no light leakage

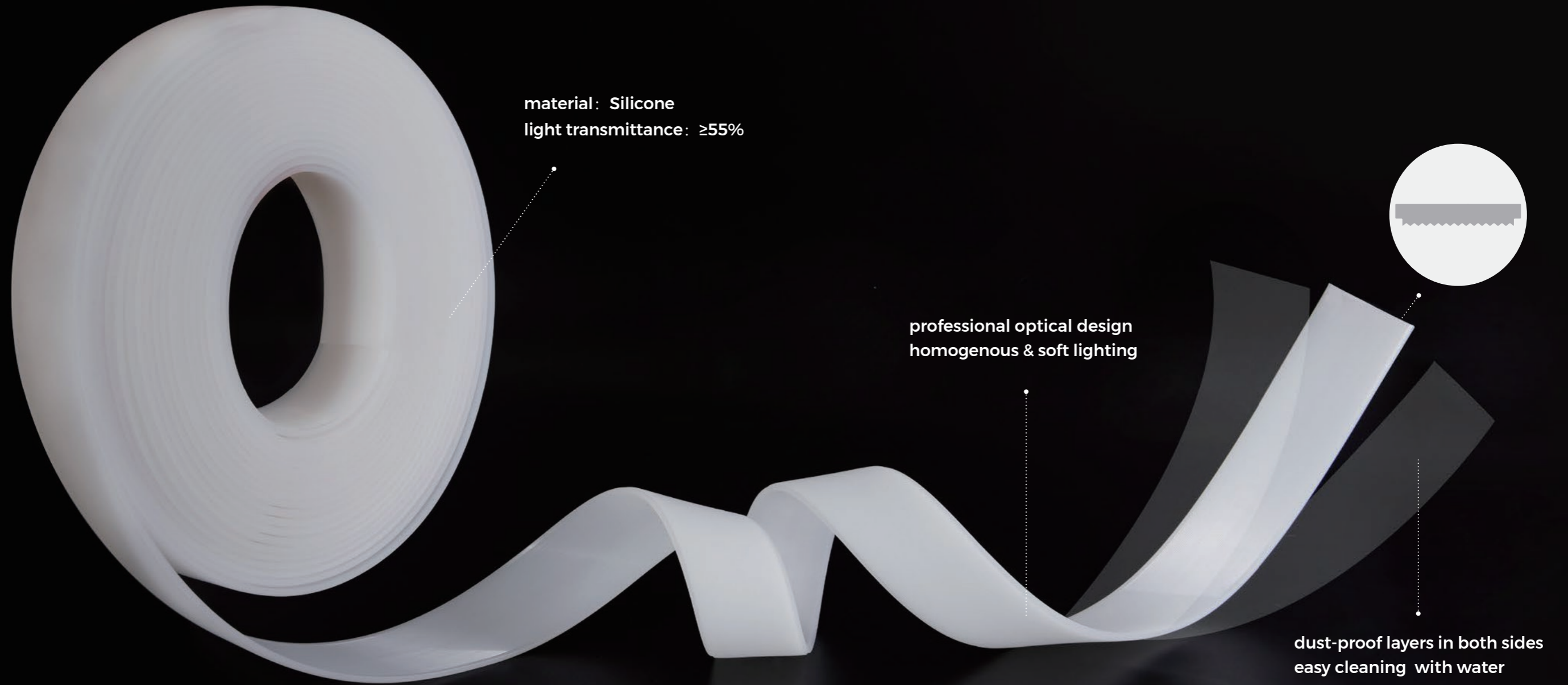

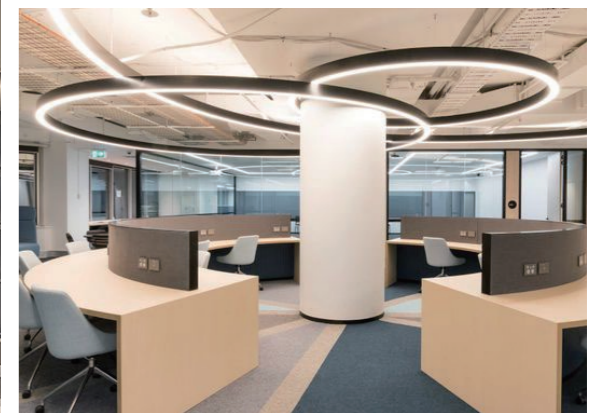

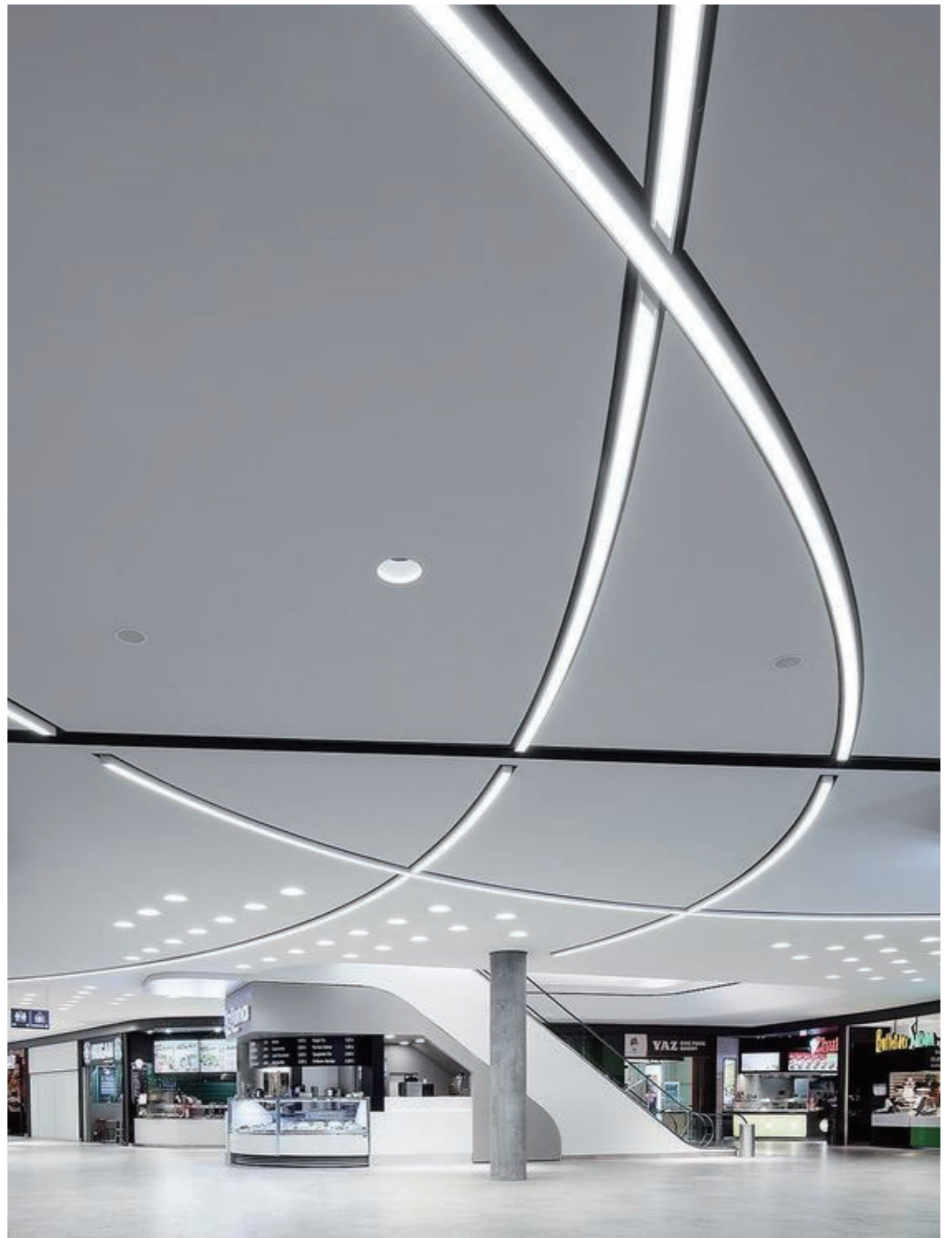

# Product Overview

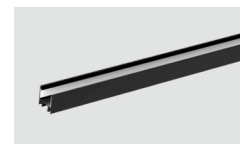
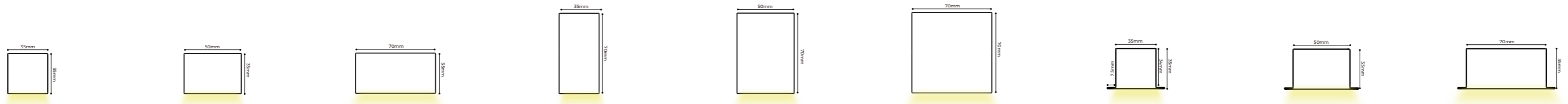

CS3535

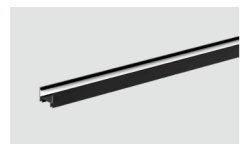

CS5035

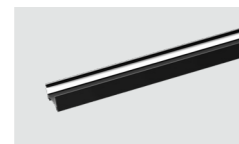

CS7035

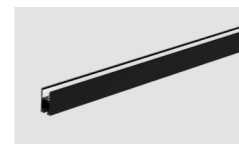

CS3570

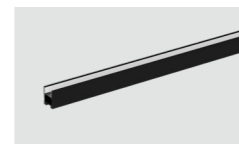

CS5070

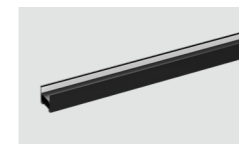

CS7070



CE3535

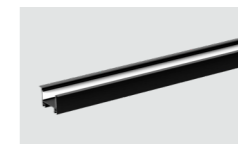

CE5035



CE7035



CS3535-A45



CS5035-A45



CS7035-A45



CS3570-A60

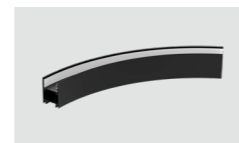

CS5070-A60

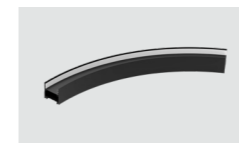

CS7070-A60



CE3535-A45



CE5035-A45



CE7035-A45

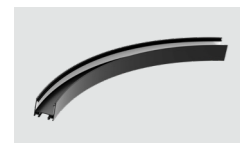

CS3535-A60



CS5035-A60



CS7035-A60



CS3570-A90

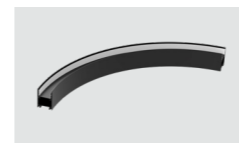

CS5070-A90



CS7070-A90



CE3535-A60

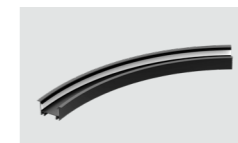

CE5035-A60



CE7035-A60

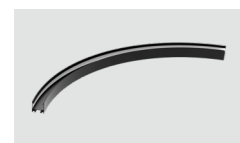

CS3535-A90

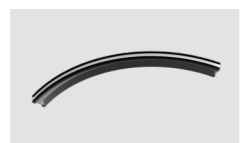

CS5035-A90



CS7035-A90



CS3570-A120

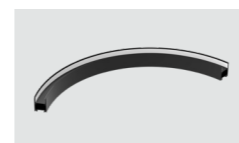

CS5070-A120



CS7070-A120



CE3535-A90



CE5035-A90



CE7035-A90

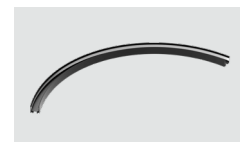

CS3535-A120



CS5035-A120



CS7035-A120

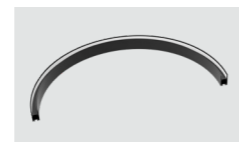

CS3570-A180

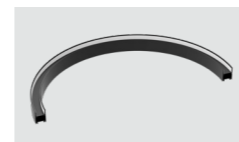

CS5070-A180



CS7070-A180



CE3535-A120



CE5035-A120



CE7035-A120

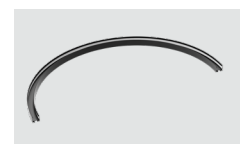

CS3535-A180

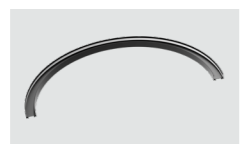

CS5035-A180

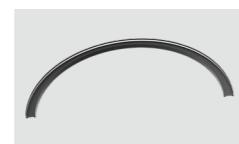

CS7035-A180

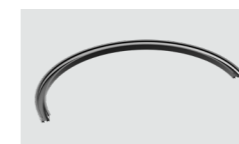

CE3535-A180



CE5035-A180



CE7035-A180

# CSXX35 Series Ceiling&Pendant Lighting Solution

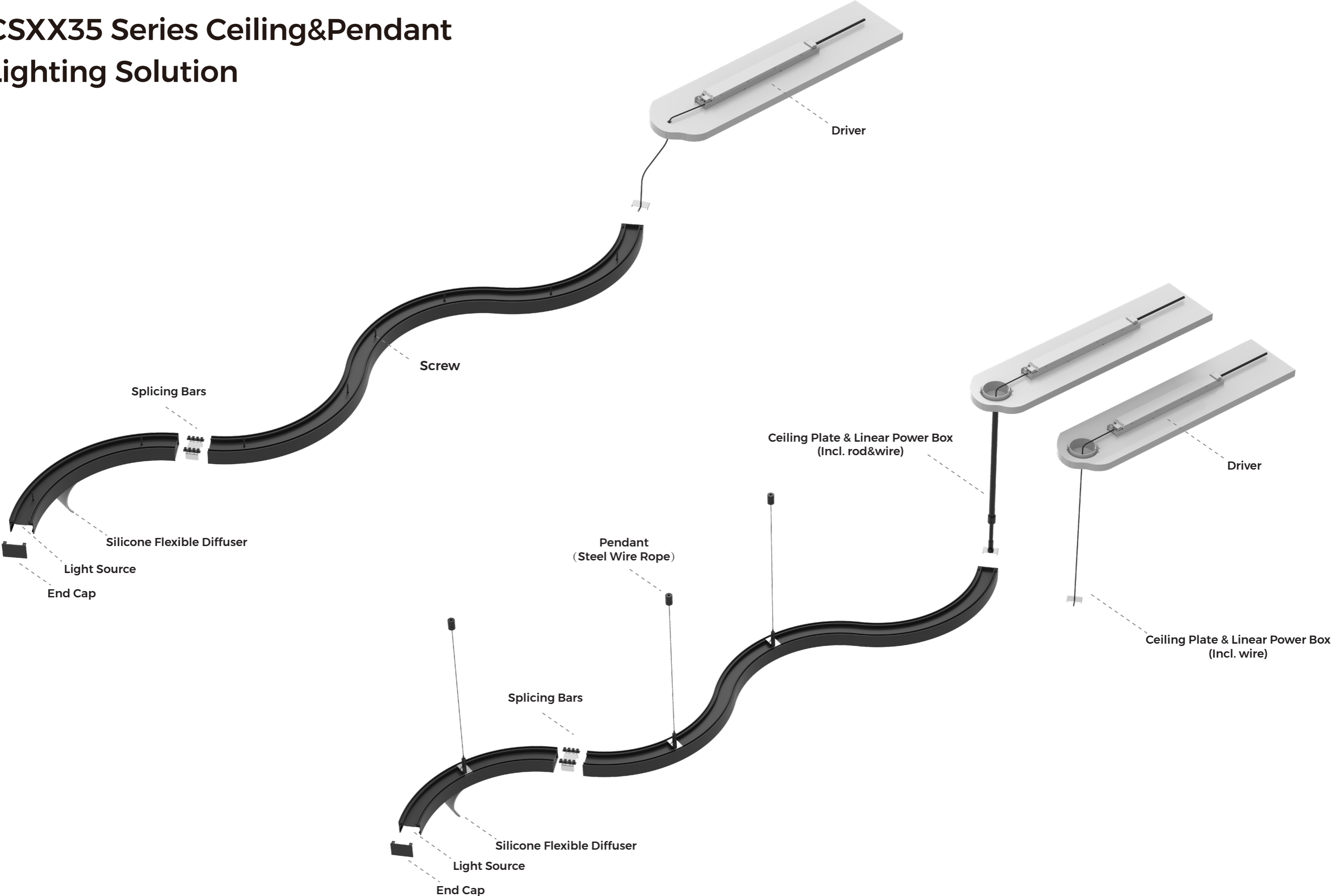

# CS3535 Series

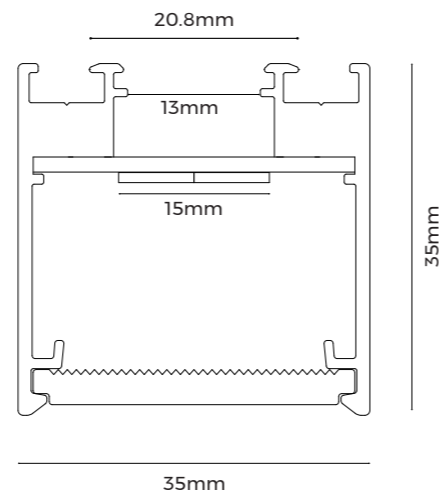
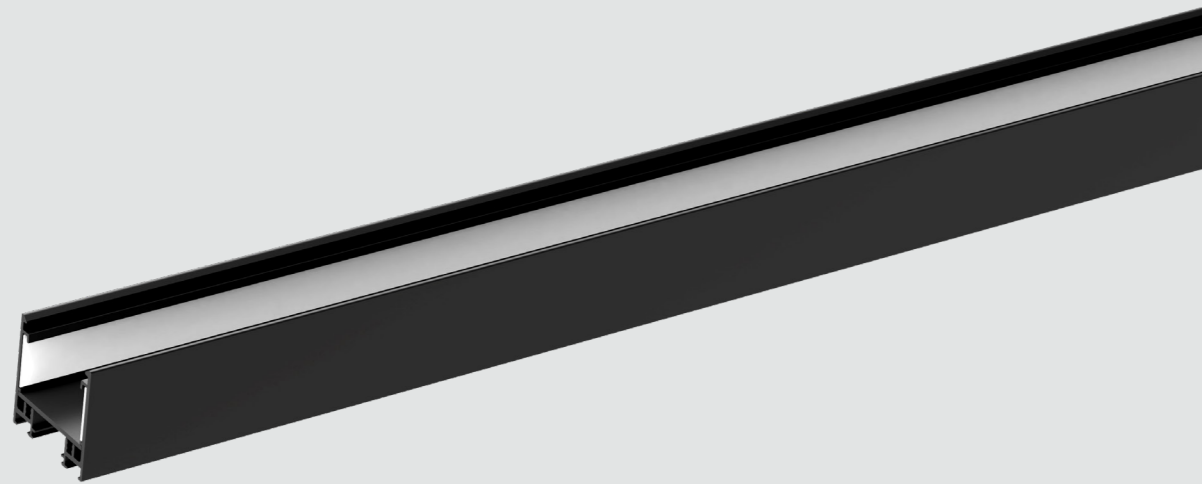

Parameters	
Material	AL6063-T5, Spraying
Light efficiency	70LM/W (RA80,4000K White)
Coating	White(RAL9003) ○ Black(RAL9005) ● Silver(RAL9006) ●
Installation	Pendant, Ceiling
Lighting direction	Downward
Application	Indoor
Certification	ROHS, Reach
IP Grade	IP20
Warranty	5 years

## CS3535

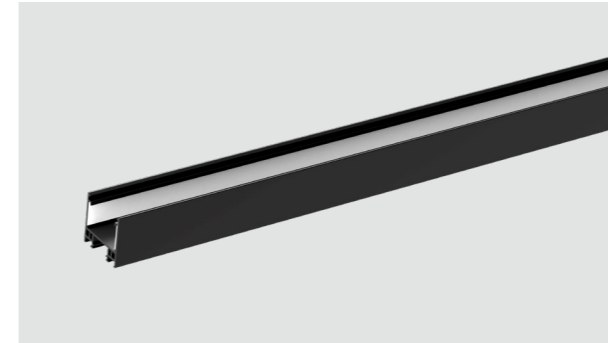

Dimension(length)

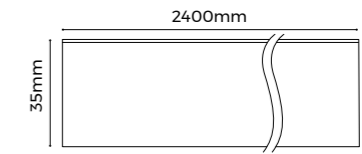

## CS3535-A45



Dimension(external diameter)

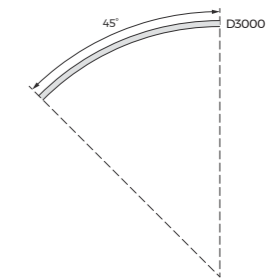

## CS3535-A60



Dimension(external diameter)

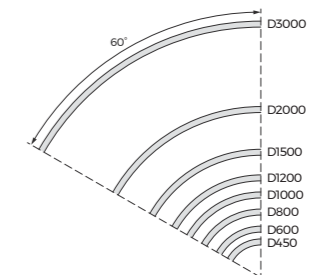

## CS3535-A90

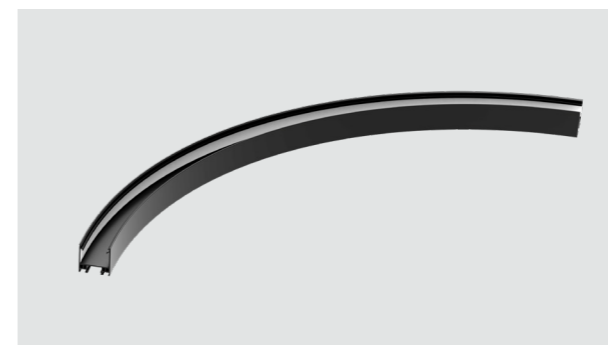

Dimension(external diameter)

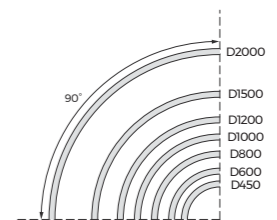

## CS3535-A120

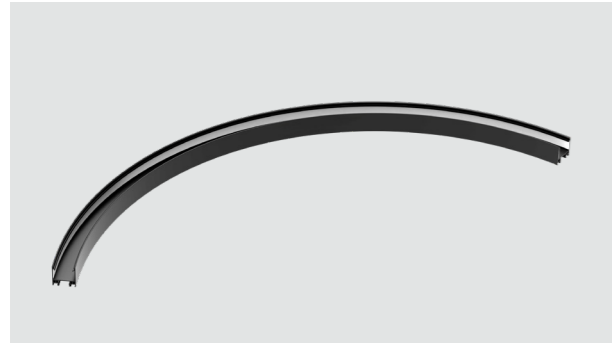

Dimension(external diameter)

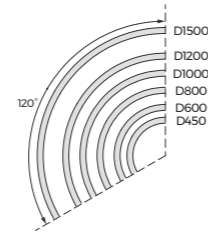

## CS3535-A180

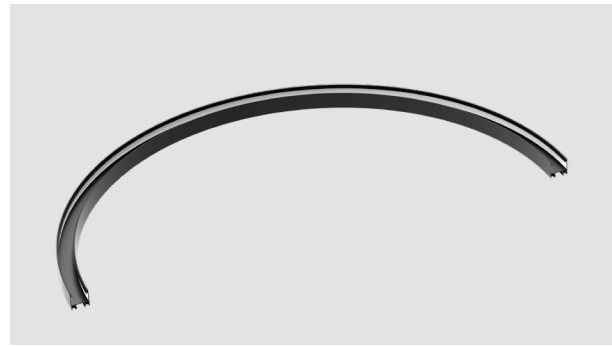

Dimension(external diameter)

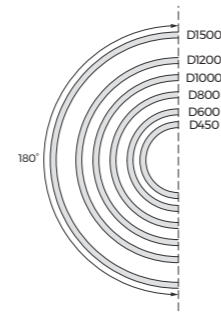

## Light Distribution

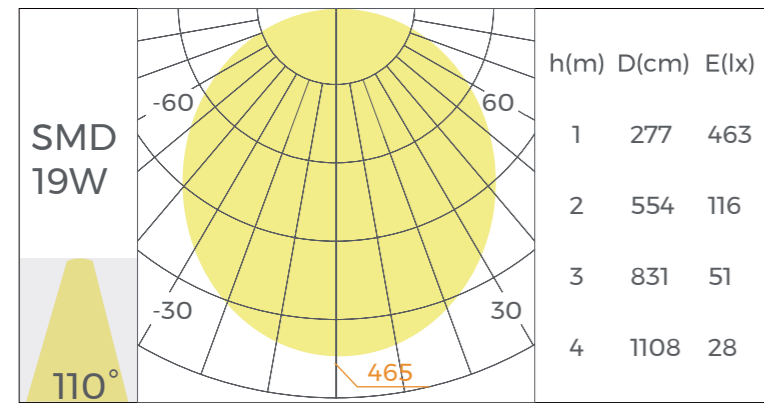

\*The above data is based on a 1000mm length luminaire with Ra80,4000K.

### Lighting Source

Picture	Model	LEDs/pcs	CRI	CCT	Voltage	Typ.power	Max.power	Lumens(RA80)	Size	Cutting unit
	DS8160-24V-15mm	160LEDs/M	80/90	2700/3000K 3500/4000K 5000/6500K	24V	19.2W/M	22.1W/M	2900lm/M(4000K)	5000x15x1.5mm	50mm/8Leds
	DS8320-24V-15mm	320LEDs/M	80/90	2700K+6500K	24V	38.4W/M	42.2W/M	2701lm/M(2700K) 2910lm/M(6500K)	4000x15x1.5mm	50mm/16Leds
	DA168-24V-15mm	168LEDs/M	NO	RGB	24V	20W/M	22W/M	756lm/M(RGB)	5000x15x1.5mm	35.7mm/6Leds
	DMA120-24V-15mm	120LEDs/M	NO	RBC(DMX)	24V	25W/M	27.5W/M	724lm/M(RGB)	4000x15x1.5mm	50mm/6Leds

## Accessory

Picture	Name	Model	Description	Picture	Name	Model	Description
	Ceiling screw	CL-01	Material: Carbon Steel Size: M3.5*40mm Quantity: 4PCS/set		Power supply	LF-GHY240H24	Dimming mode: Non-Dimming Power: 240W Input voltage: AC220-240V Output voltage: DC24V Output current: ≤10A Size: 361*33.1*22.8mm Certification: ENEC,CE,CB,RCM, UKCA,MM,CCC
	Ceiling plate (incl. wire)	PP-A	Material: Fe/spraying Maximum weight capacity: 3Kg Size: Ceiling Plate: D88*29mm Wire: D3*2000mm Open hole: D75mm Quantity: 1PCS/set		Power supply	BK-MGV100-24V0M	Dimming mode: 1-10V Dimming Power: 100W Input voltage: AC200-240V Output voltage: DC24V Output current: ≤4.2A Size: 355*30*21mm Certification: TUV, CE, RCM
	Ceiling plate (incl. rod&wire)	PP-G	Material: Fe/spraying Maximum weight capacity: 3Kg Size: Ceiling Plate: D88*29mm/Rod: 1-2 meter adjustable/Wire: D3*2000mm Open hole: D75mm Quantity: 1PCS/set		Power supply	BK-MEV200-24V0M	Dimming mode: 1-10V Dimming Power: 200W Input voltage: AC200-240V Output voltage: DC24V Output current: ≤8.3A Size: 321*48*30mm Certification: CE, ENEC, UKCA, RCM, CCC, EL
	Linear power Box (incl. wire)	PB-09	Material: SPCC/spraying Maximum weight capacity: 8Kg Size: Power Box: L401*W50*H46mm Wire: D3*2000mm Quantity: 1PCS/set		Power supply	BK-DGV100-24V0D	Dimming mode: DALI Dimming Power: 100W Input voltage: AC200-240V Output voltage: DC24V Output current: ≤4.2A Size: 355*30*21mm Certification: CE, ENEC, UKCA, RCM, CCC, EL
	Linear power box (incl. rod&wire)	PB-10	Material: SPCC/spraying Size: Power Box: L401*W50*H46mm Rod: 1-2 meter adjustable Wire: D3*2000mm Quantity: 1PCS/set		Power supply	BK-DEV200-24V0D	Dimming mode: DALI2, PUSH-dimming, 1-10V 3in1 dimming Power: 200W Input voltage: AC200-240V Output voltage: DC24V Output current: ≤8.3A Size: 361*33.1*22.8mm Certification: TUV, CE, RCM
	Pendant rod	PG-1	Rod Size: 1-2 meter adjustable Quantity: 2PCS/set		CCT control receiver	CR2-GBA	Input voltage: 24VDC Max load current: 8A*3CH, Max 18A Max load power: 384W@24V Operating temperature: -30°C-55°C Product Size: L175*W50*H23mm
	Pendant rope	PN-D	Steel Wire Rope: 2M Maximum weight capacity: 17.5Kg Quantity: 2PCS/set		CCT Remote	CK2-GBA	Operating Voltage: 3VDC Working frequency: 2.4GHz Remote control distance: 30m Operating temperature: -30°C-55°C Product Size: L107*W58.5*H9mm
	Pendant clips	CP-53	Material: SUS304 Size: L22.67*W20*H5.3mm Quantity: 4PCS/set		RGB control receiver	CR3-GBA	Input Voltage: 12-48V Output Current: 6A*3CH, Max 18A Output Power: 216W/332W@12V/24V, 648W/864@36V/48V Dimming Mode: RGB/RF2.4G remote control IP: IP20 Product Size: L175*W45*H27mm
	Splicing bars	EX-E15	Applicable product model: CS3535, CE3535 Material: SPCC/ Electrophoresis Size: L31.5*W30*H18mm Quantity: 1PCS/set		RGBW Remote	R8-1	Working Voltage: 3VDC (Battery CR2032) Operating Frequency: 2.4GHz Remote Control Distance: 30m Operating Temperature: -30°C-55°C Product Size: L107*W58.5*H9mm
	Diffuser	CV-CS3535D	Material: Silicone Light transmittance: ≥55% Size: 2000*0*32*3.5mm		Programmable digital controller	K-1000C	Input voltage: 5-24V Control Pixel Points: Point Control 1CH*1024(SPI), Point Control 1CH*512(DMX) Dimming mode: DMX/SPI control IP: IP20 Warranty: 5 years
	End Caps	EC-MS3535	Material: Aluminum/spraying Size: L35*W35*H2.5mm Quantity: 2PCS/set		Programmable digital controller	K-8000C	Input Voltage: 5-24V Control Pixel Points: Point Control 8CH*1024(SPI), Point Control 8CH*512(DMX) Dimming mode: DMX/SPI control IP: IP20 Warranty: 5 years
	Power supply	LF-GHY100H24	Dimming mode: Non-Dimming Power: 100W Input voltage: AC220-240V Output voltage: DC24V Output current: ≤4.25A Size: 316*30.7*22.8mm Certification: ENEC, CE, CB, RCM, UKCA, MM, CCC				

# CS5035 Series

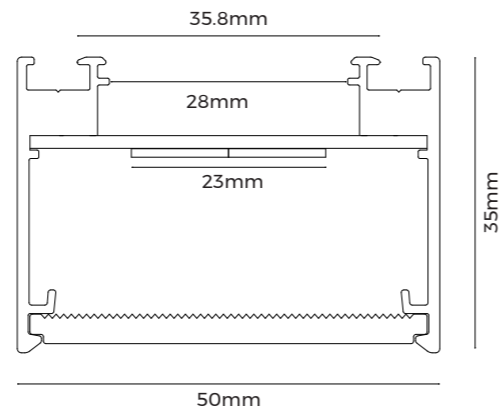
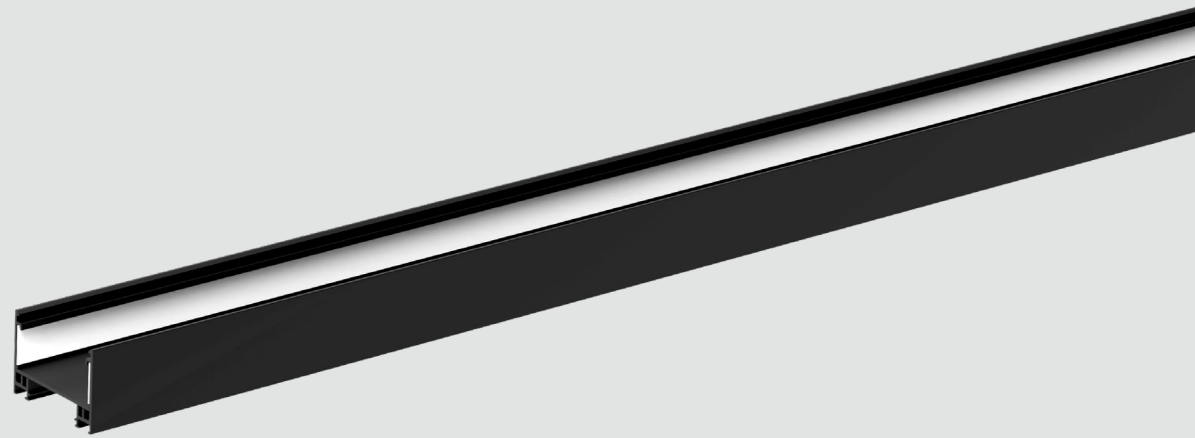

Parameters	
Material	AL6063-T5, Spraying
Light efficiency	90LM/W (RA80,4000K White)
Coating	White(RAL9003) ○ Black(RAL9005) ● Silver(RAL9006) ●
Installation	Pendant, Ceiling
Lighting direction	Downward
Application	Indoor
Certification	ROHS, Reach
IP Grade	IP20
Warranty	5 years

## CS5035

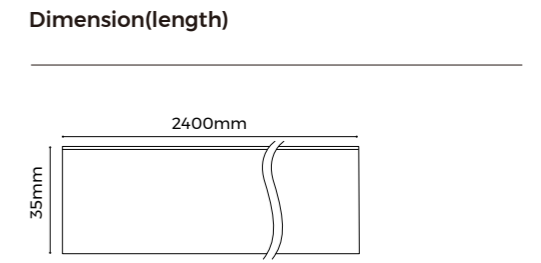
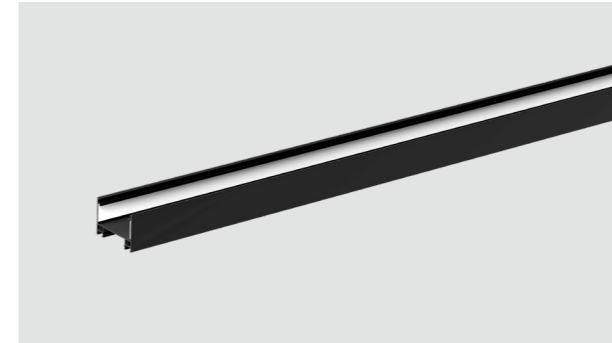

## CS5035-A45

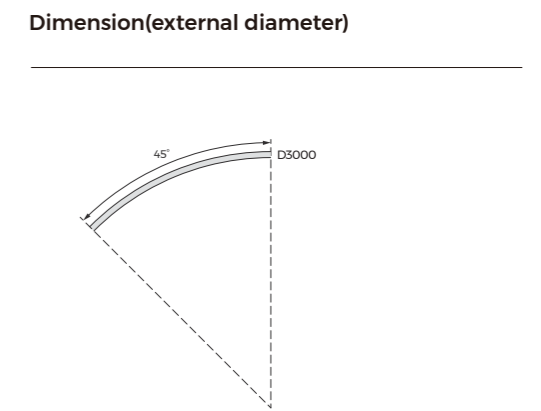

## CS5035-A60

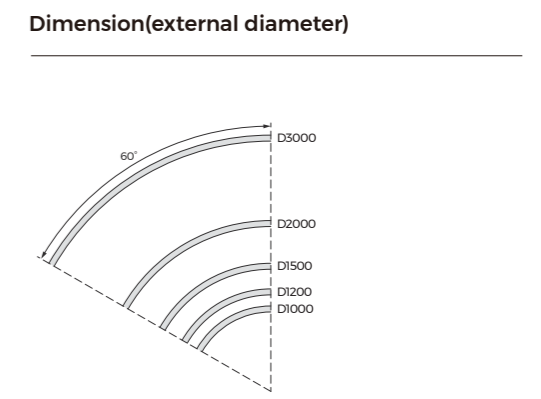
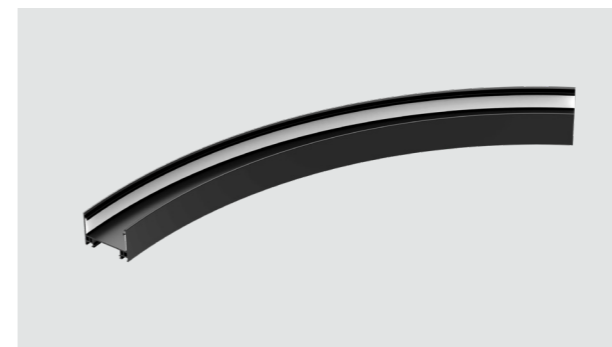

## CS5035-A90

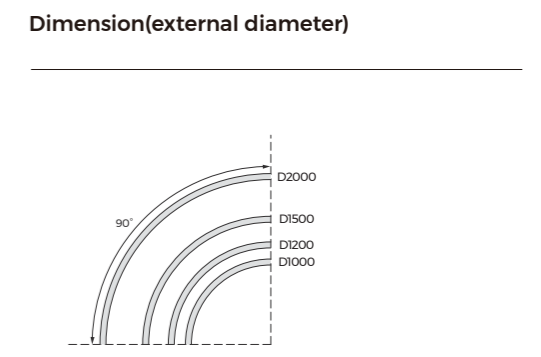
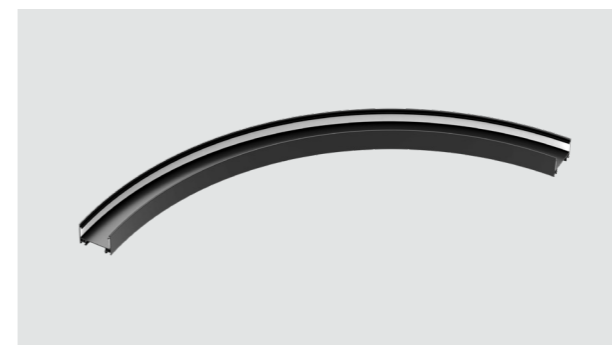

## CS5035-A120

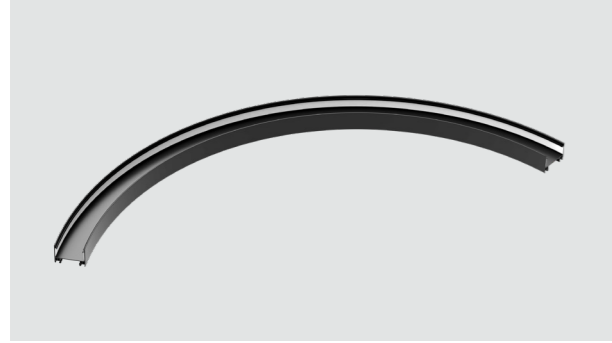

Dimension(external diameter)

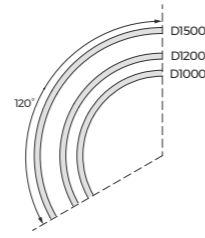

## CS5035-A180

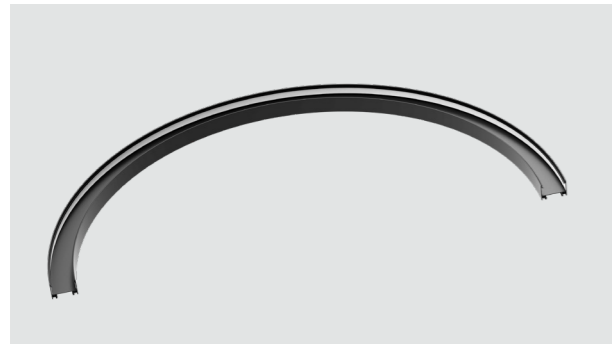

Dimension(external diameter)

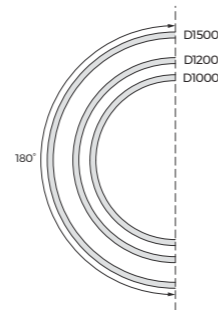

## Light Distribution

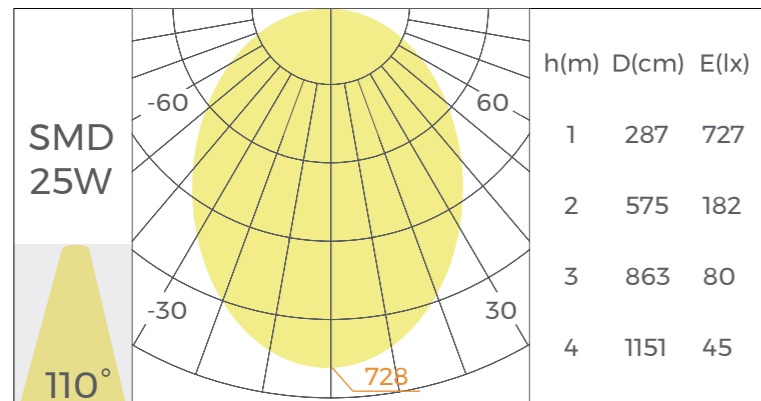

\*The above data is based on a 1000mm length luminaire with Ra80,4000K.

### Lighting Source

Picture	Model	LEDs/pcs	CRI	CCT	Voltage	Typ.power	Max.power	Lumens	Size	Cutting unit
	DS8160-24V-23mm	160LEDs/M	80/90	2700/3000K 3500/4000K 5000/6500K	24V	24W/M	26.4W/M	3600lm/M(4000K)	4000x23x1.5mm	50mm/8Leds
	DS8320-24V-23mm	320LEDs/M	80/90	2700K+6500K	24V	48W/M	52.8W/M	3240lm/M(2700K) 3408lm/M(6500K)	3000x23x1.5mm	50mm/16Leds

## Accessory

Picture	Name	Model	Description	Picture	Name	Model	Description
	Ceiling screw	CL-01	Material: Carbon Steel Size: M3.5*40mm Quantity: 4 PCS/set		End Caps	EC-MS5035	Material: Aluminum/spraying Size: L50*W35*H2.5mm Quantity: 2PCS/set
	Ceiling plate (incl. wire)	PP-A	Material: Fe/spraying Maximum weight capacity: 3Kg Size: Ceiling Plate: D88*29mm Wire: D3*2000mm Open hole: D75mm Quantity: 1PCS/set		Power supply	LF-GHY100H24	Dimming mode: Non-Dimming Power: 100W Input voltage: AC220-240V Output voltage: DC24V Output current: <math>\leq 2.5A</math> Size: 316*33*17.22.8mm Certification: ENEC,CE,CB,RCM, UKCA,MM,CCC
	Ceiling plate (incl. rod&wire)	PP-G	Material: Fe/spraying Maximum weight capacity: 3Kg Size: Ceiling Plate: D88*29mm/Rod: 1-2 meter adjustable/Wire: D3*2000mm Open hole: D75mm Quantity: 1PCS/set		Power supply	LF-GHY240H24	Dimming mode: Non-Dimming Power: 240W Input voltage: AC220-240V Output voltage: DC24V Output current: <math>\le 10A</math> Size: 361*33*17.22.8mm Certification: ENEC,CE,CB,RCM, UKCA,MM,CCC
	Linear power Box (incl. wire)	PB-09	Material: SPCC/spraying Maximum weight capacity: 8Kg Size: Power Box: L401*W50*H46mm Wire: D3*2000mm Quantity: 1PCS/set		Power supply	BK-MGV100-24VOM	Dimming mode: 1-10V Dimming Power: 100W Input voltage: AC200-240V Output voltage: DC24V Output current: <math>\le 4.2A</math> Size: 355*30*21mm Certification: TUV, CE, RCM
	Linear power box (incl. rod&wire)	PB-10	Material: SPCC/spraying Size: Power Box: L401*W50*H46mm Rod: 1-2 meter adjustable Wire: D3*2000mm Quantity: 1PCS/set		Power supply	BK-MEV200-24VOM	Dimming mode: 1-10V Dimming Power: 200W Input voltage: AC200-240V Output voltage: DC24V Output current: <math>\le 8.3A</math> Size: 321.5*48*30mm Certification: CE, ENEC, UKCA, RCM, CCC, EL
	Pendant rod	PG-1	Rod Size: 1-2 meter adjustable Quantity: 2PCS/set		Power supply	BK-DGV100-24VOD	Dimming mode: DALI Dimming Power: 100W Input voltage: AC200-240V Output voltage: DC24V Output current: <math>\le 4.2A</math> Size: 355*30*21mm Certification: CE, ENEC, UKCA, RCM, CCC, EL
	Pendant rope	PN-D	Steel Wire Rope: 2M Maximum weight capacity: 17.5Kg Quantity: 2PCS/set		Power supply	BK-DEV200-24VOD	Dimming mode: DALI2, PUSH-dimming, 1-10V 3in1 dimming Power: 200W Input voltage: AC200-240V Output voltage: DC24V Output current: <math>\le 8.3A</math> Size: 361*33*17.22.8mm Certification: TUV, CE, RCM
	Pendant clips	CP-54	Material: SUS304 Size: L37.87*W20*H5.4mm Quantity: 4PCS/set		CCT control receiver	CR2-GBA	Input voltage: 24VDC Max load current: 8A*3CH, Max 18A Max load power: 384W@24V Operating temperature: -30 C ~ 55 C Product Size: L175*W50*H23mm
	Splicing bars	EX-E16	Applicable product model: CS5035, CE5035 Material: SPCC/ Electrophoresis Size: L46.5*W50*H18mm Quantity: 1 PCS/set		CCT Remote	CK2-GBA	Operating Voltage: 3VDC Working frequency: 2.4GHz Remote control distance: 30m Operating temperature: -30 C ~ 55 C Product Size: L107*W58.5*H9mm
	Diffuser	CV-CS5035D	Material: Silicone Light transmittance: >=55% Size: 2000*47*4mm				

# CS7035 Series

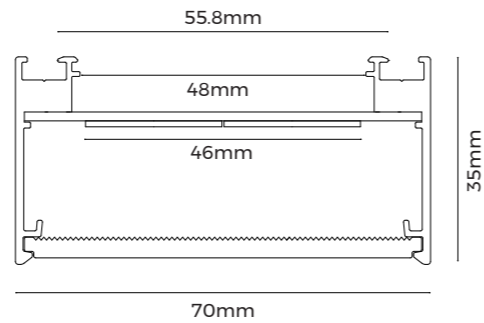
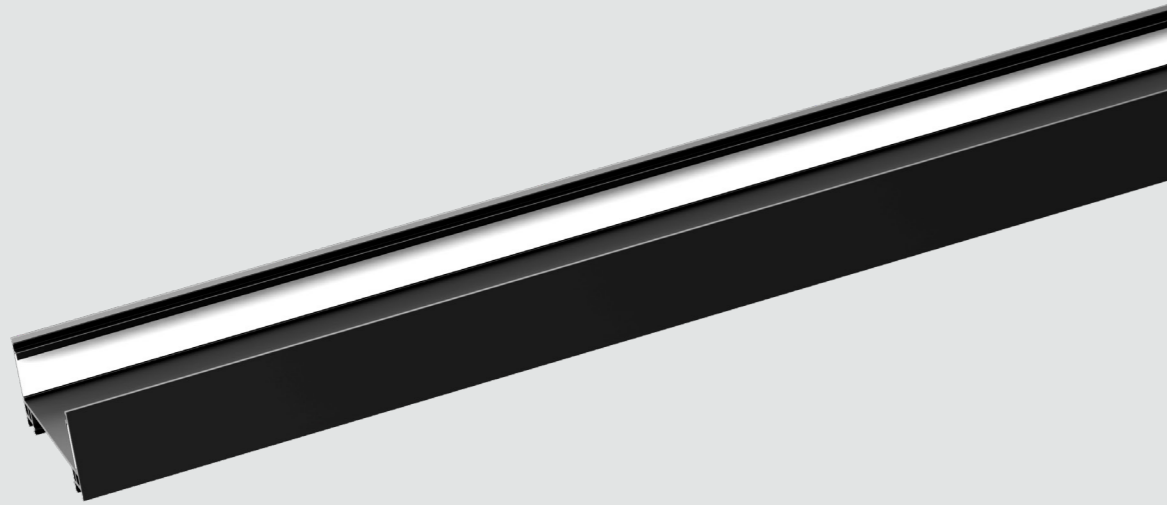

Parameters	
Material	AL6063-T5, Spraying
Light efficiency	85LM/W (RA80,4000K White)
Coating	White(RAL9003) ○ Black(RAL9005) ● Silver(RAL9006) ●
Installation	Pendant, Ceiling
Lighting direction	Downward
Application	Indoor
Certification	ROHS, Reach
IP Grade	IP20
Warranty	5 years

## CS7035

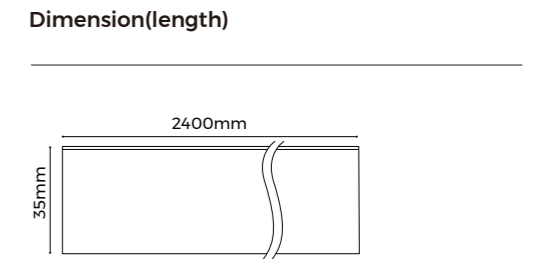
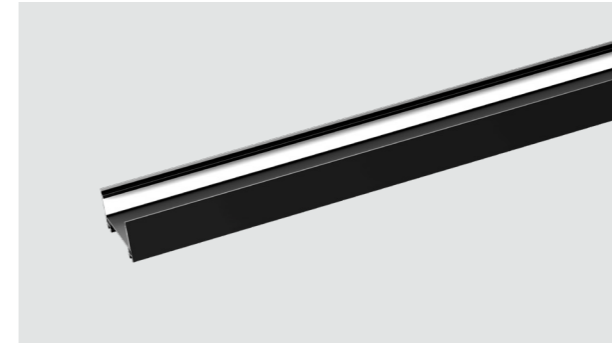

## CS7035-A45

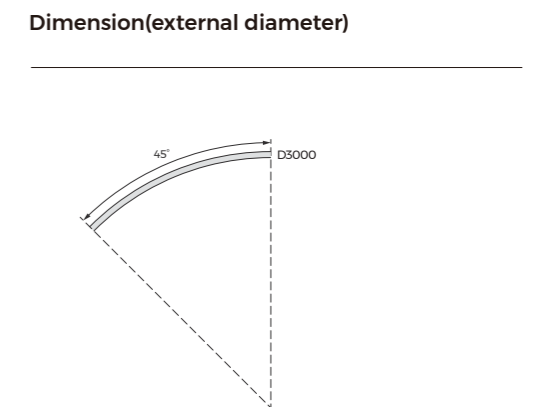

## CS7035-A60

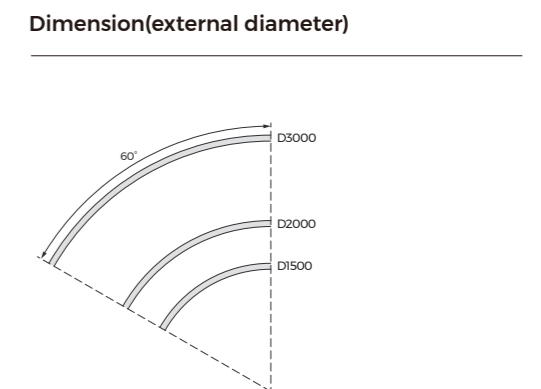
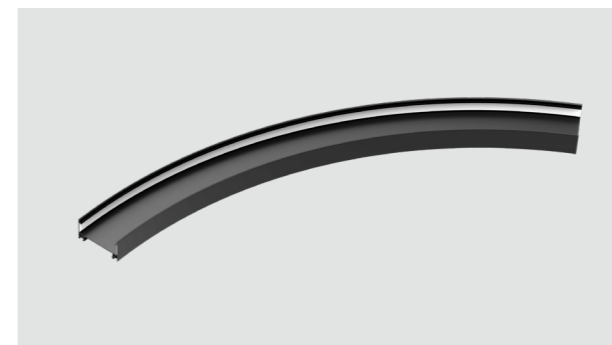

## CS7035-A90

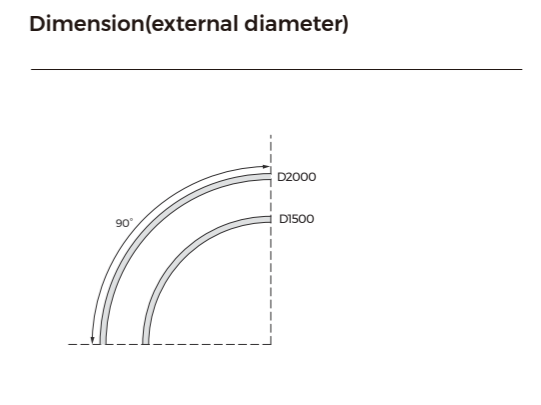

## CS7035-A120



Dimension(external diameter)

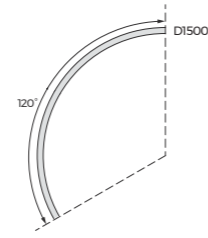

## CS7035-A180

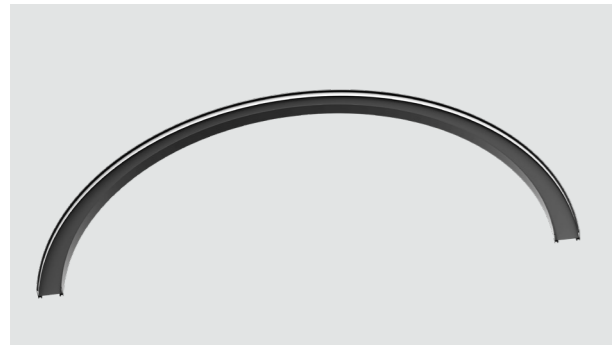

Dimension(external diameter)

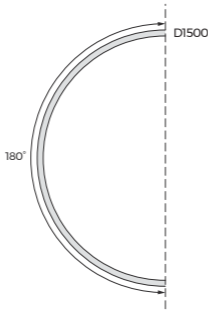

## Light Distribution

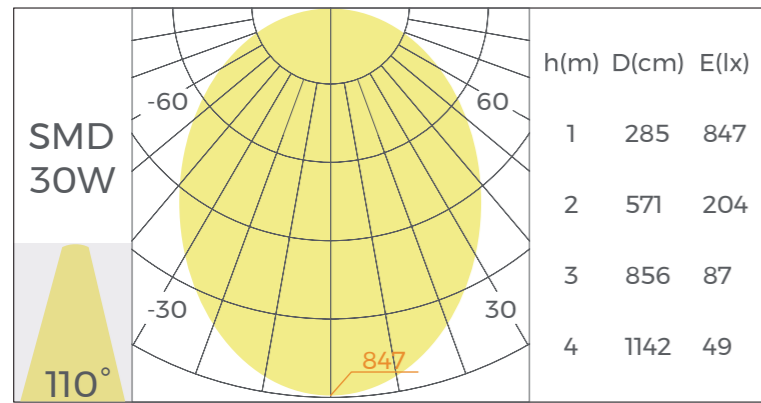

\*The above data is based on a 1000mm length luminaire with Ra80,4000K.

### Lighting Source

Picture	Model	LEDs/pcs	CRI	CCT	Voltage	Typ.power	Typ.power	Lumens	Size	Cutting unit
	DS8160-24V-23mm	160LEDs/M	80/90	2700/3000K 3500/4000K 5000/6500K	24V	14.4W/M	15.8W/M	2300lm/M(4000K)	5000x23x1.5mm	50mm/8Leds
	DS8320-24V-23mm	320LEDs/M	80/90	2700K+6500K	24V	28.8W/M	31.6W/M	1944m/M(2700K) 2131lm/M(6500K)	4000x23x1.5mm	50mm/16Leds

## Accessory

Picture	Name	Model	Description	Picture	Name	Model	Description
	Ceiling screw	CL-01	Material: Carbon Steel Size: M3.5*40mm Quantity: 4 PCS/set		End Caps	EC-MS7035	Material: Aluminum/spraying Size: L70*W35*H2.5mm Quantity: 2PCS/set
	Ceiling plate (incl. wire)	PP-A	Material: Fe/spraying Maximum weight capacity: 3Kg Size: Ceiling Plate: D88*29mm Wire: D3*2000mm Open hole: D75mm Quantity: 1PCS/set		Power supply	LF-GHY100H24	Dimming mode: Non-Dimming Power: 100W Input voltage: AC220-240V Output voltage: DC24V Output current: ≤4.25A Size: 316*30*7*22.8mm Certification: ENEC,CE,CB,RCM, UKCA,MM,CCC
	Ceiling plate (Incl. rod&wire)	PP-G	Material: Fe/spraying Maximum weight capacity: 3Kg Size: Ceiling Plate: D88*29mm/Rod: 1-2 meter adjustable/Wire: D3*2000mm Open hole: D75mm Quantity: 1PCS/set		Power supply	LF-GHY240H24	Dimming mode: Non-Dimming Power: 240W Input voltage: AC220-240V Output voltage: DC24V Output current: ≤10A Size: 361*33*1*22.8mm Certification: ENEC,CE,CB,RCM, UKCA,MM,CCC
	Linear power Box (incl. wire)	PB-09	Material: SPCC/spraying Maximum weight capacity: 8Kg Size: Power Box: L401*W50*H46mm Wire: D3*2000mm Quantity: 1PCS/set		Power supply	BK-MGV100-24VOM	Dimming mode: 1-10V Dimming Power: 100W Input voltage: AC200-240V Output voltage: DC24V Output current: ≤4.2A Size: 355*30*21mm Certification: TUV, CE, RCM
	Linear power box (Incl. rod&wire)	PB-10	Material: SPCC/spraying Size: Power Box: L401*W50*H46mm Rod: 1-2 meter adjustable Wire: D3*2000mm Quantity: 1PCS/set		Power supply	BK-MEV200-24VOM	Dimming mode: 1-10V Dimming Power: 200W Input voltage: AC200-240V Output voltage: DC24V Output current: ≤8.3A Size: 321.5*48*30mm Certification: CE, ENEC, UKCA, RCM, CCC, EL
	Pendant rod	PG-1	Rod Size: 1-2 meter adjustable Quantity: 2PCS/set		Power supply	BK-DGV100-24VOD	Dimming mode: DALI Dimming Power: 100W Input voltage: AC200-240V Output voltage: DC24V Output current: ≤4.2A Size: 355*30*21mm Certification: CE, ENEC, UKCA, RCM, CCC, EL
	Pendant rope	PN-D	Steel Wire Rope: 2M Maximum weight capacity: 17.5Kg Quantity: 2PCS/set		Power supply	BK-DEV200-24VOD	Dimming mode: DALI2, PUSH-dimming, 1-10V 3in1 dimming Power: 200W Input voltage: AC200-240V Output voltage: DC24V Output current: ≤8.3A Size: 361*33*1*22.8mm Certification: TUV, CE, RCM
	Pendant clips	CP-55	Material: SUS304 Size: L57.8*W20*H5.4mm Quantity: 4PCS/set		CCT control receiver	CR2-GBA	Input voltage: 24VDC Max load current: 8A*5CH, Max 18A Max load power: 384W@24V Operating temperature: -30 C ~ 55 C Product Size: L175*W50*H23mm
	Splicing bars	EX-E17	Applicable product model: CS7035, CE7035 Material: SPCC/ Electrophoresis Size: L66.5*W50*H18mm Quantity: 1 PCS/set		CCT Remote	CK2-GBA	Operating Voltage: 3VDC Working frequency: 2.4GHz Remote control distance: 30m Operating temperature: -30 C ~ 55 C Product Size: L107*W58.5*H9mm
	Diffuser	CV-CS7035D	Material: Silicone Light transmittance: ≥55% Size: 20000*67.2*5mm				

# CSXX70 Series Ceiling&Pendant Lighting Solution

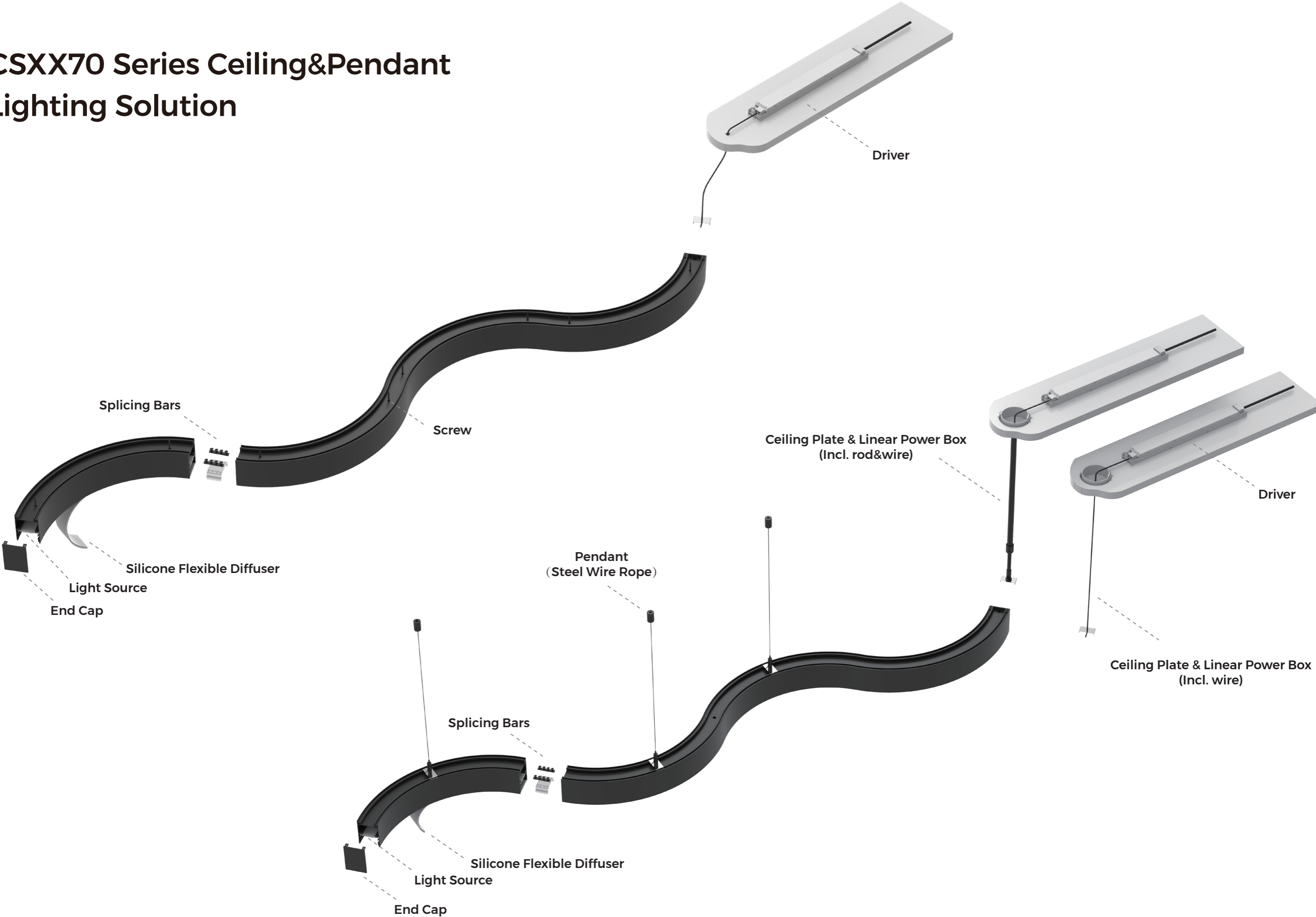

# CS3570 Series

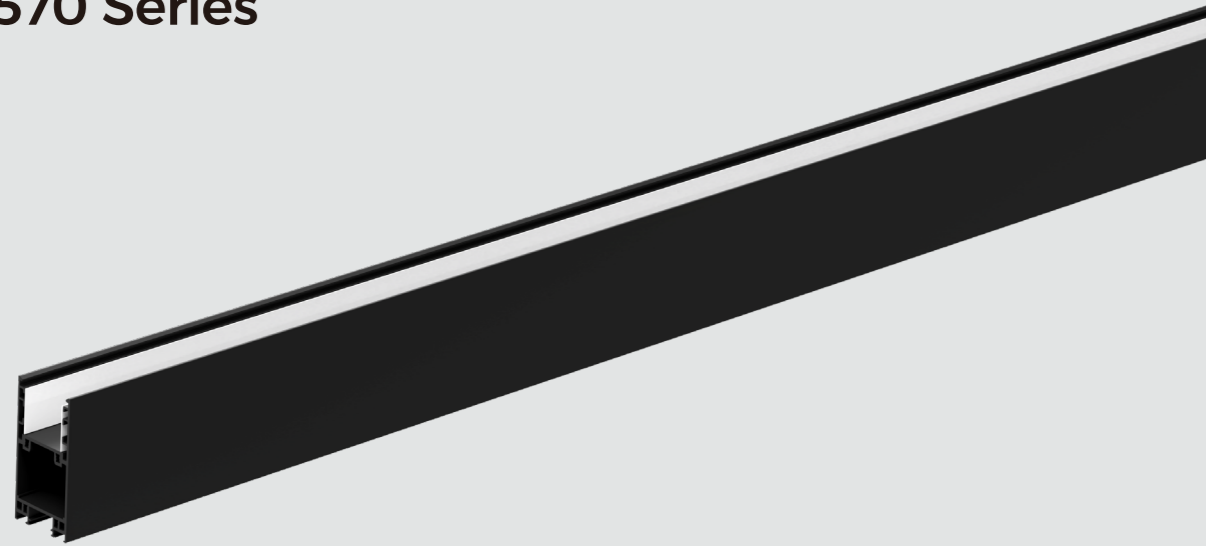

Parameters	
Material	AL6063-T5, Spraying
Light efficiency	70LM/W (RA80,4000K White)
Coating	White(RAL9003) ○ Black(RAL9005) ● Silver(RAL9006) ●
Installation	Pendant, Ceiling
Lighting direction	Downward
Application	Indoor
Certification	ROHS, Reach
IP Grade	IP20
Warranty	5 years

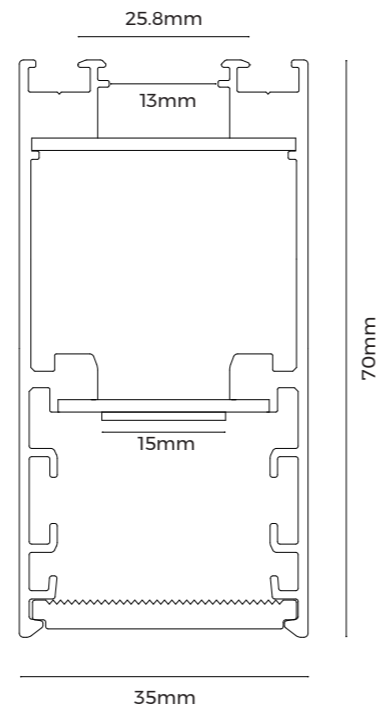

## CS3570

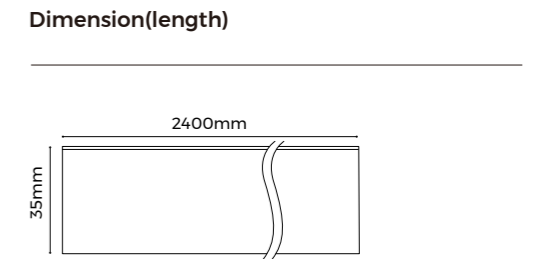
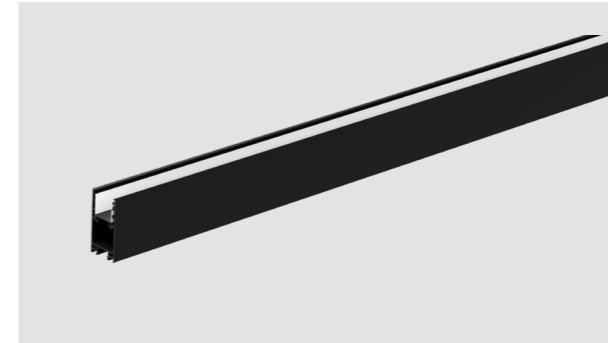

## CS3570-A60

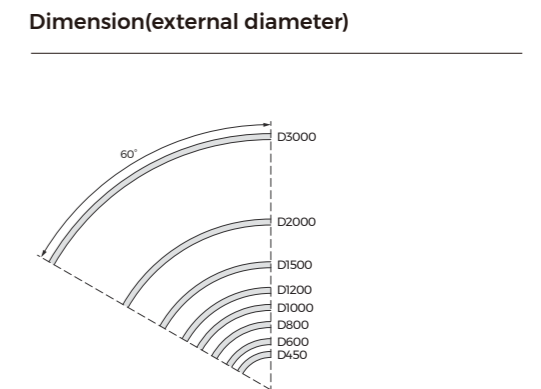
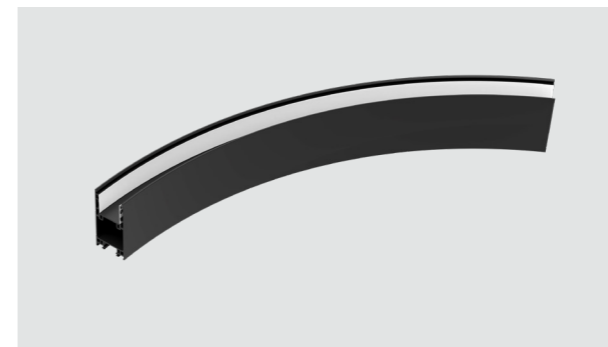

## CS3570-A90

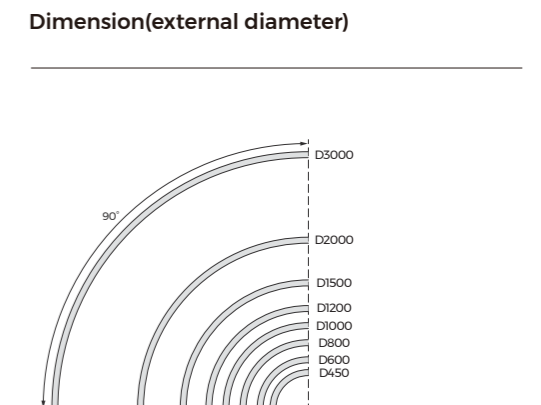
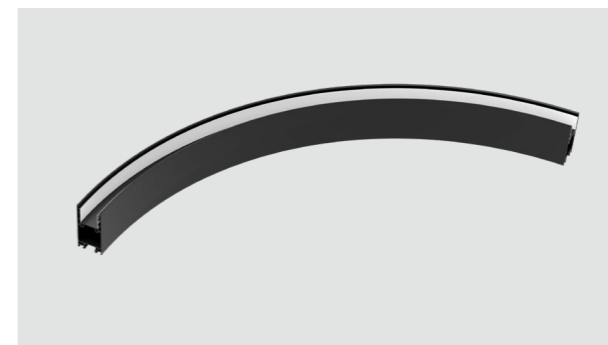

## CS3570-A120

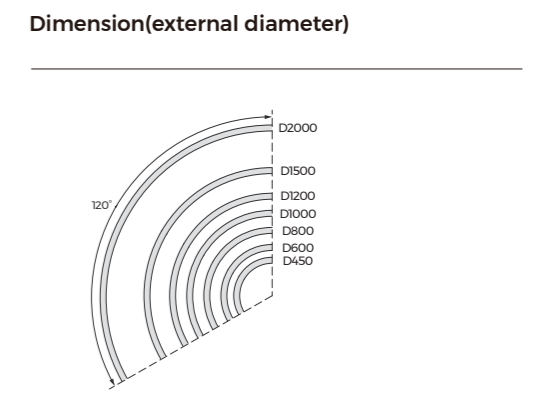
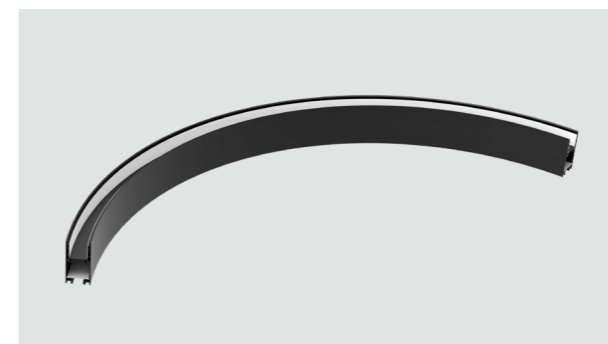

# CS3570-A180

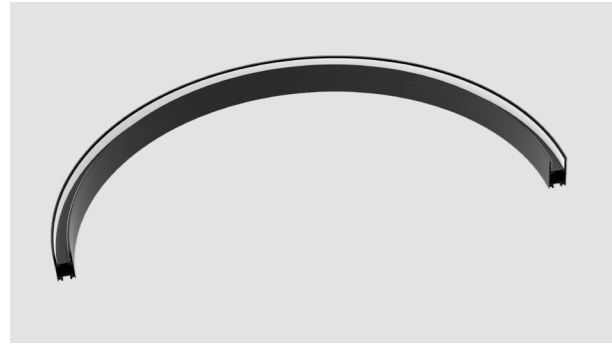

## Dimension(external diameter)

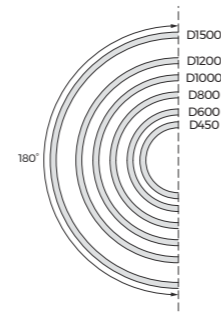

## Light Distribution

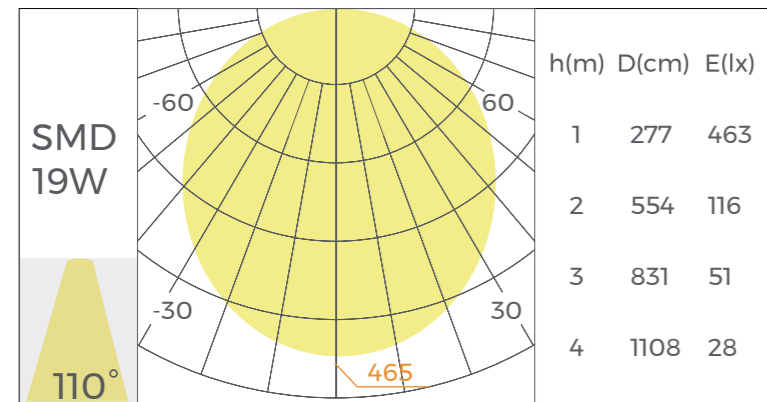

\*The above data is based on a 1000mm length luminaire with Ra80,4000K.

Lighting Source										
Picture	Model	LEDs/pcs	CRI	CCT	Voltage	Typ.power	Maxpower	Lumens(RA80)	Size	Cutting unit
	DS8160-24V-15mm	160LEDs/M	80/90	2700/3000K 3500/4000K 5000/6500K	24V	19.2W/M	22.1W/M	2900lm/M(4000K)	5000x15x1.5mm	50mm/8Leds
	DS8320-24V-15mm	320LEDs/M	80/90	2700K+6500K	24V	38.4W/M	42.2W/M	2701lm/M(2700K) 2910lm/M(6500K)	4000x15x1.5mm	50mm/16Leds
	DA168-24V-15mm	168LEDs/M	NO	RGB	24V	20W/M	22W/M	756lm/M(RGB)	5000x15x1.5mm	35.7mm/6Leds
	DMA120-24V-15mm	120LEDs/M	NO	RBG(DMX)	24V	25W/M	27.5W/M	724lm/M(RGB)	4000x15x1.5mm	50mm/6Leds

## Accessory

Picture	Name	Model	Description	Picture	Name	Model	Description
	Ceiling screw	CL-01	Material: Carbon Steel Size: M3.5*40mm Quantity: 4 PCS/set		Power supply	LF-GHY240H24	Dimming mode: Non-Dimming Power: 240W Input voltage: AC220-240V Output voltage: DC24V Output current: ≤10A Size: 361*33.1*22.8mm Certification: ENEC,CE,CB,RCM, UKCA,MM,CCC
	Ceiling plate (incl. wire)	PP-A	Material: Fe/spraying Maximum weight capacity: 3Kg Size: Ceiling Plate: D88*29mm Wire: D3*2000mm Open hole: D75mm Quantity: 1PCS/set		Power supply	BK-MGV100-24V0M	Dimming mode: 1-10V Dimming Power: 100W Input voltage: AC200-240V Output voltage: DC24V Output current: ≤4.2A Size: 355*30*21mm Certification: TUV, CE, RCM
	Ceiling plate (incl. rod&wire)	PP-G	Material: Fe/spraying Maximum weight capacity: 3Kg Size: Ceiling Plate: D88*29mm/Rod: 1-2 meter adjustable/Wire: D3*2000mm Open hole: D75mm Quantity: 1PCS/set		Power supply	BK-MEV200-24V0M	Dimming mode: 1-10V Dimming Power: 200W Input voltage: AC200-240V Output voltage: DC24V Output current: ≤8.3A Size: 321.5*48*30mm Certification: CE, ENEC, UKCA, RCM, CCC, EL
	Linear power Box (incl. wire)	PB-09	Material: SPCC/spraying Maximum weight capacity: 8Kg Size: Power Box: L401*W50*H46mm Wire: D3*2000mm Quantity: 1PCS/set		Power supply	BK-DGV100-24V0D	Dimming mode: DALI Dimming Power: 100W Input voltage: AC200-240V Output voltage: DC24V Output current: ≤4.2A Size: 355*30*21mm Certification: CE, ENEC, UKCA, RCM, CCC, EL
	Linear power box (incl. rod&wire)	PB-10	Material: SPCC/spraying Size: Power Box: L401*W50*H46mm Rod: 1-2 meter adjustable Wire: D3*2000mm Quantity: 1PCS/set		Power supply	BK-DEV200-24V0D	Dimming mode: DALI2, PUSH-dimming, 1-10V 3in1 dimming Power: 200W Input voltage: AC200-240V Output voltage: DC24V Output current: ≤8.3A Size: 361*33.1*22.8mm Certification: TUV, CE, RCM
	Pendant rod	PG-1	Rod Size: 1-2 meter adjustable Quantity: 2PCS/set		CCT control receiver	CR2-GBA	Input voltage: 24VDC Max load current: 8A*3CH, Max 18A Max load power: 384W@24V Operating temperature: -30°C-55°C Product Size: L175*W50*H23mm
	Pendant rope	PN-D	Steel Wire Rope: 2M Maximum weight capacity: 17.5Kg Quantity: 2 PCS/set		CCT Remote	CK2-GBA	Operating Voltage: 3VDC Working frequency: 2.4GHz Remote control distance: 30m Operating temperature: -30°C-55°C Product Size: L107*W58.5*H9mm
	Pendant clips	CP-53	Material: SUS304 Size: L22.67*W20*H5.3mm Quantity: 4 PCS/set		RGB control receiver	CR3-GBA	Input Voltage: 12-48V Output Current: 6A*3CH, Max 18A Output Power: 216W/332W@12V/24V, 648W/864@36V/48V Dimming Mode: RGB/RF2.4G remote control IP: IP20 Product Size: L175*W45*H27mm
	Splicing bars	EX-E18	Applicable product model: CS3570 Material: SPCC/ Electrophoresis Size: L31.8*W30*H15.7mm Quantity: 1 PCS/set		RGBW Remote	R8-1	Working Voltage: 3VDC (Battery CR2032) Operating Frequency: 2.4GHz Remote Control Distance: 30m Operating Temperature: -30°C-55°C Product Size: L107*W58.5*H9mm
	Diffuser	CV-CS3535D	Material: Silicone Light transmittance: ≥55% Size: 2000*32*3.5mm		Programmable digital controller	K-1000C	Input voltage: 5-24V Control Pixel Points: Point Control 1CH*1024(SPI), Point Control 1CH*512(DMX) Dimming mode: DMX/SPI control IP: IP20 Warranty: 5 years
	End Caps	EC-MS3570	Material: Aluminum/spraying Size: L70*W35*H2.5mm Quantity: 2PCS/set		Programmable digital controller	K-8000C	Input Voltage: 5-24V Control Pixel Points: Point Control 8CH*1024(SPI), Point Control 8CH*512(DMX) Dimming mode: DMX/SPI control IP: IP20 Warranty: 5 years
	Power supply	LF-GHY100H24	Dimming mode: Non-Dimming Power: 100W Input voltage: AC220-240V Output voltage: DC24V Output current: ≤4.25A Size: 316*30.7*22.8mm Certification: ENEC,CE,CB,RCM, UKCA,MM,CCC				

# CS5070 Series

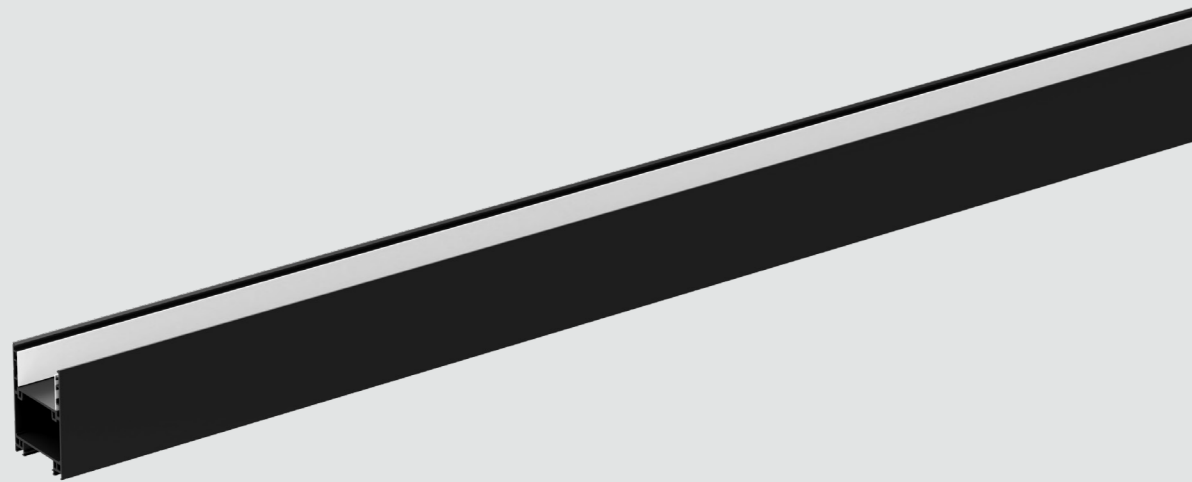

Parameters	
Material	AL6063-T5, Spraying
Light efficiency	90LM/W (RA80,4000K White)
Coating	White(RAL9003) ○ Black(RAL9005) ● Silver(RAL9006) ●
Installation	Pendant, Ceiling
Lighting direction	Downward
Application	Indoor
Certification	ROHS, Reach
IP Grade	IP20
Warranty	5 years

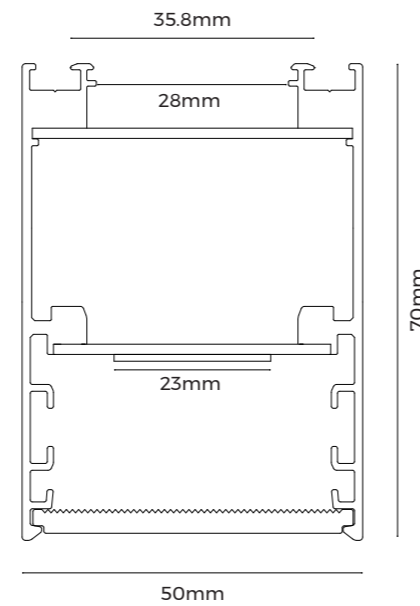

## CS5070

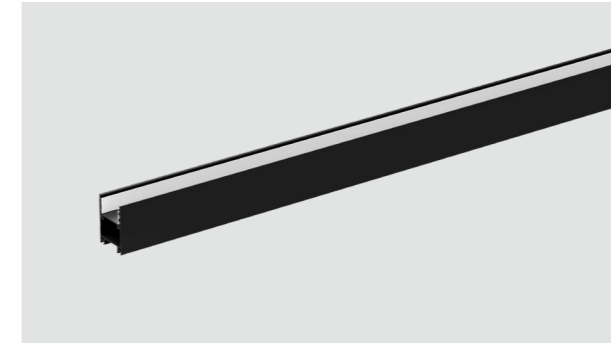

Dimension(length)

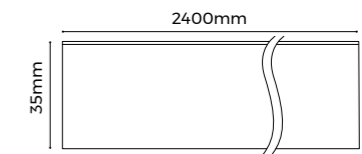

## CS5070-A60

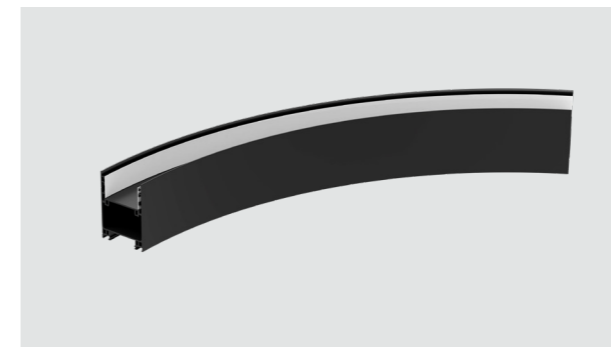

Dimension(external diameter)

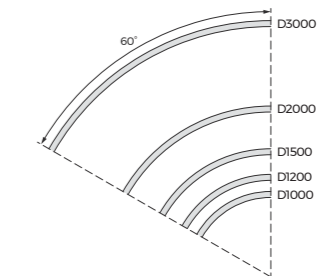

## CS5070-A90

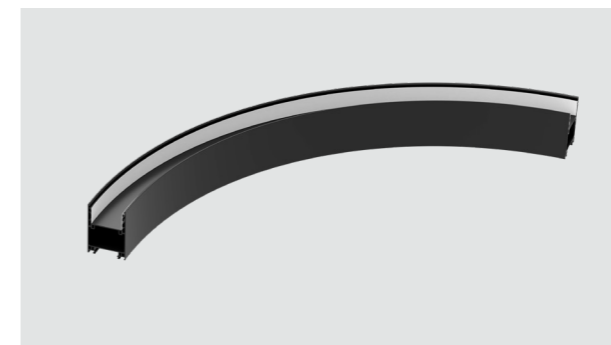

Dimension(external diameter)

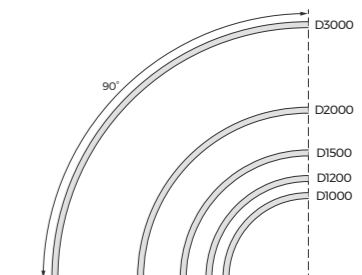

## CS5070-A120

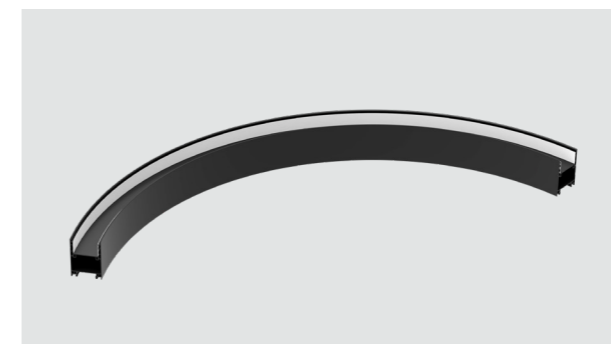

Dimension(external diameter)

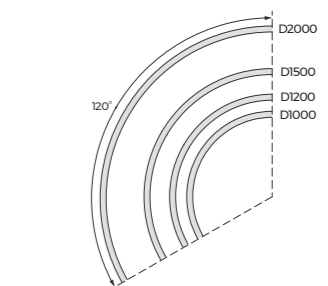

# CS5070-A180

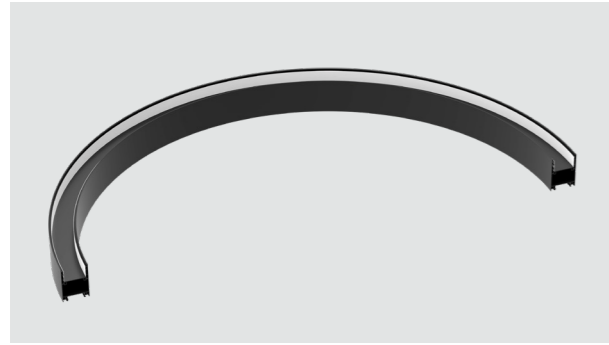

## Dimension(external diameter)

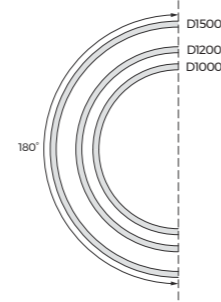

## Light Distribution

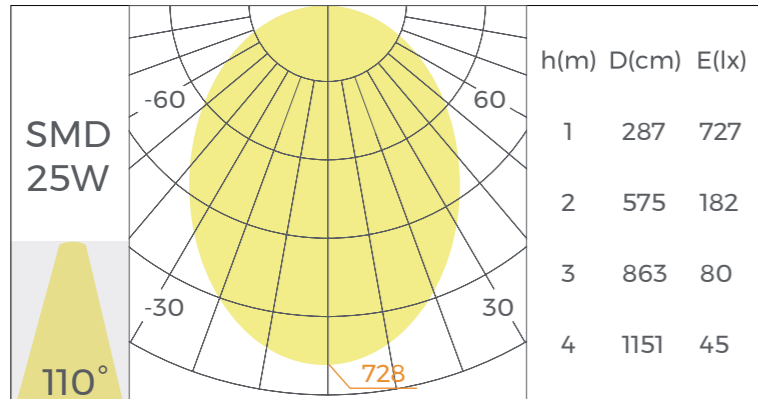

\*The above data is based on a 1000mm length luminaire with Ra80,4000K.

### Lighting Source

Picture	Model	LEDs/pcs	CRI	CCT	Voltage	Typ.power	Max.power	Lumens	Size	Cutting unit
	DS8160-24V-23mm	160LEDs/M	80/90	2700/3000K 3500/4000K 5000/6500K	24V	24W/M	26.4W/M	3600lm/M(4000K)	4000x23x1.5mm	50mm/8Leds
	DS8320-24V-23mm	320LEDs/M	80/90	2700K+6500K	24V	48W/M	52.8W/M	3240lm/M(2700K) 3408lm/M(6500K)	3000x23x1.5mm	50mm/16Leds

## Accessory

Picture	Name	Model	Description	Picture	Name	Model	Description
	Ceiling screw	CL-15	Material: Carbon Steel Size: M3.5*50mm Quantity: 2 PCS/set		End Caps	EC-MS5070	Material: Aluminum/spraying Size: L70*W50*H2.5mm Quantity: 2PCS/set
	Ceiling plate (incl. wire)	PP-A	Material: Fe/spraying Maximum weight capacity: 3Kg Size: Ceiling Plate: D88*29mm Wire: D3*2000mm Open hole: D75mm Quantity: 1PCS/set		Power supply	LF-GHY100H24	Dimming mode: Non-Dimming Power: 100W Input voltage: AC220-240V Output voltage: DC24V Output current: ≤4.25A Size: 316*30*7*22.8mm Certification: ENEC,CE,CB,RCM, UKCA,MM,CCC
	Ceiling plate (incl. rod&wire)	PP-G	Material: Fe/spraying Maximum weight capacity: 3Kg Size: Ceiling Plate: D88*29mm/Rod: 1-2 meter adjustable/Wire: D3*2000mm Open hole: D75mm Quantity: 1PCS/set		Power supply	LF-GHY240H24	Dimming mode: Non-Dimming Power: 240W Input voltage: AC220-240V Output voltage: DC24V Output current: ≤10A Size: 361*33*1*22.8mm Certification: ENEC,CE,CB,RCM, UKCA,MM,CCC
	Linear power Box (incl. wire)	PB-09	Material: SPCC/spraying Maximum weight capacity: 8Kg Size: Power Box: L401*W50*H46mm Wire: D3*2000mm Quantity: 1PCS/set		Power supply	BK-MGV100-24V0M	Dimming mode: 1-10V Dimming Power: 100W Input voltage: AC200-240V Output voltage: DC24V Output current: ≤4.2A Size: 355*30*21mm Certification: TUV, CE, RCM
	Linear power box (incl. rod&wire)	PB-10	Material: SPCC/spraying Size: Power Box: L401*W50*H46mm Rod: 1-2 meter adjustable Wire: D3*2000mm Quantity: 1PCS/set		Power supply	BK-MEV200-24V0M	Dimming mode: 1-10V Dimming Power: 200W Input voltage: AC200-240V Output voltage: DC24V Output current: ≤8.3A Size: 321.5*48*30mm Certification: CE, ENEC, UKCA, RCM, CCC, EL
	Pendant rod	PG-I	Rod Size: 1-2 meter adjustable Quantity: 2PCS/set		Power supply	BK-DGV100-24V0D	Dimming mode: DALI Dimming Power: 100W Input voltage: AC200-240V Output voltage: DC24V Output current: ≤4.2A Size: 355*30*21mm Certification: CE, ENEC, UKCA, RCM, CCC, EL
	Pendant rope	PN-D	Steel Wire Rope: 2M Maximum weight capacity: 17.5Kg Quantity: 2PCS/set		Power supply	BK-DEV200-24V0D	Dimming mode: DALI2, PUSH-dimming, 1-10V 3in1 dimming Power: 200W Input voltage: AC200-240V Output voltage: DC24V Output current: ≤8.3A Size: 361*33*1*22.8mm Certification: TUV, CE, RCM
	Pendant clips	CP-54	Material: SUS304 Size: L37.87*W20*H5.4mm Quantity: 4PCS/set		CCT control receiver	CR2-GBA	Input voltage: 24VDC Max load current: 8A*3CH, Max 18A Max load power: 384W@24V Operating temperature: -30 C ~ 55 C Product Size: L175*W50*H23mm
	Splicing bars	EX-E19	Applicable product model: CS5070 Material: SPCC/ Electrophoresis Size: L46.8*W30*H15.7mm Quantity: 1 PCS/set		CCT Remote	CK2-GBA	Operating Voltage: 3VDC Working frequency: 2.4GHz Remote control distance: 30m Operating temperature: -30 C ~ 55 C Product Size: L107*W58.5*H9mm
	Diffuser	CV-CS5035D	Material: Silicone Light transmittance: ≥55% Size: 2000*47*4mm				

# CS7070 Series

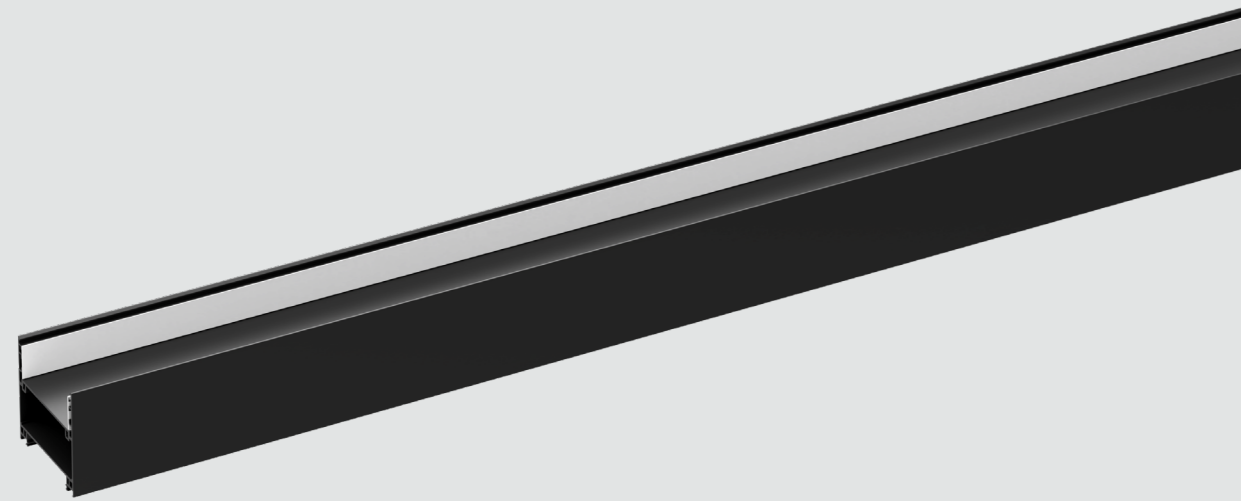

Parameters	
Material	AL6063-T5, Spraying
Light efficiency	85LM/W (RA80,4000K White)
Coating	White(RAL9003) <input type="radio"/> Black(RAL9005) <input checked="" type="radio"/> Silver(RAL9006) <input type="radio"/>
Installation	Pendant, Ceiling
Lighting direction	Downward
Application	Indoor
Certification	ROHS, Reach
IP Grade	IP20
Warranty	5 years

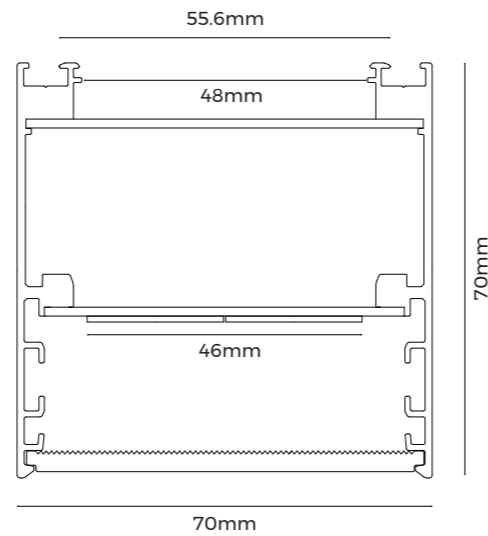

## CS7070

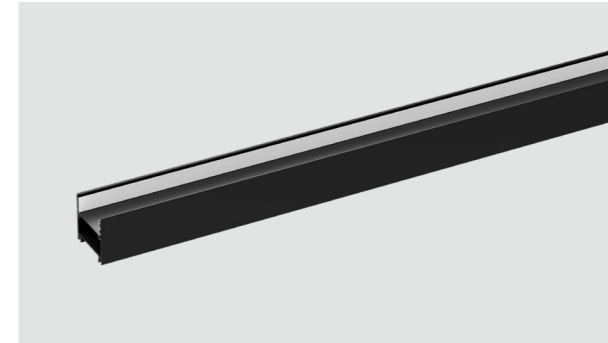

Dimension(length)

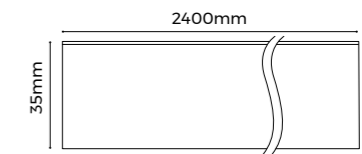

## CS7070-A60

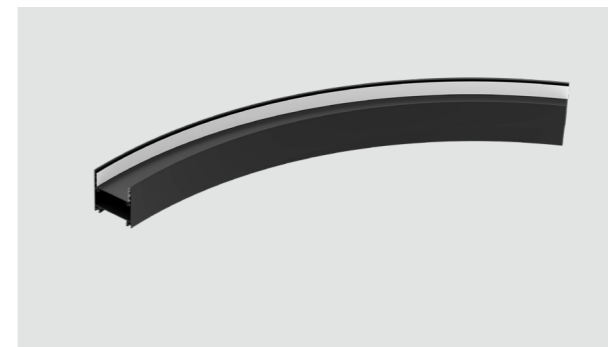

Dimension(external diameter)

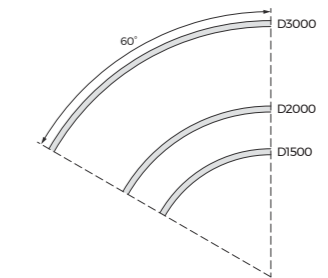

## CS7070-A90

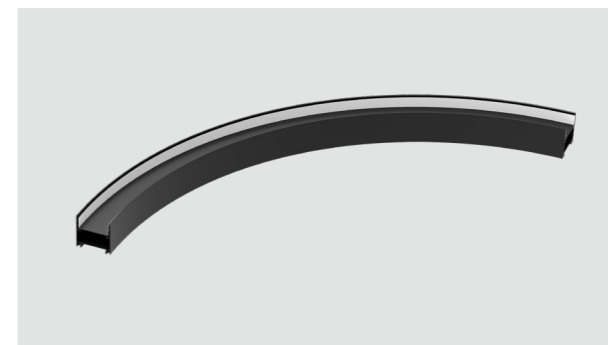

Dimension(external diameter)

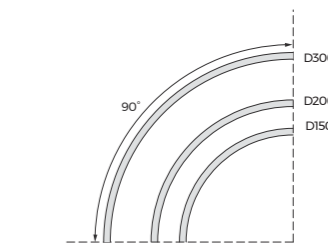

## CS7070-A120



Dimension(external diameter)

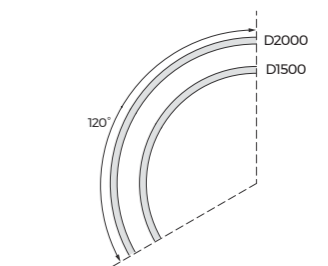

# CS7070-A180

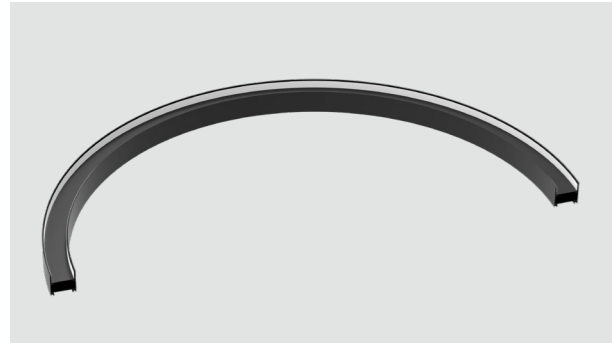

## Dimension(external diameter)

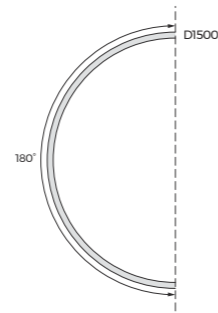

## Light Distribution

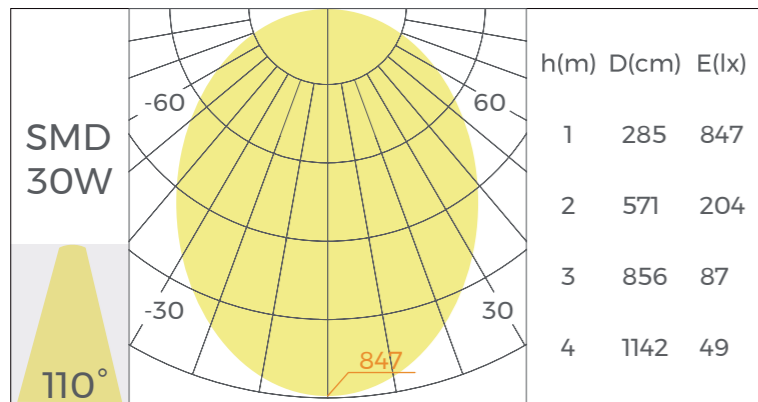

\*The above data is based on a 1000mm length luminaire with Ra80,4000K.

### Lighting Source

Picture	Model	LEDs/pcs	CRI	CCT	Voltage	Typ.power	Typ.power	Lumens	Size	Cutting unit
	DS8160-24V-23mm	160LEDs/M	80/90	2700/3000K 3500/4000K 5000/6500K	24V	14.4W/M	15.8W/M	2300lm/M(4000K)	5000x23x1.5mm	50mm/8Leds
	DS8320-24V-23mm	320LEDs/M	80/90	2700K+6500K	24V	28.8W/M	31.6W/M	1944m/M(2700K) 2131lm/M(6500K)	4000x23x1.5mm	50mm/16Leds

## Accessory

Picture	Name	Model	Description	Picture	Name	Model	Description
	Ceiling screw	CL-15	Material: Carbon Steel Size: M3.5*50mm Quantity: 2 PCS/set		End Caps	EC-MS7070	Material: Aluminum/spraying Size: L70*W70*H2.5mm Quantity: 2PCS/set
	Ceiling plate (incl. wire)	PP-A	Material: Fe/spraying Maximum weight capacity: 3Kg Size: Ceiling Plate: D88*29mm Wire: D3*2000mm Open hole: D75mm Quantity: 1PCS/set		Power supply	LF-GHY100H24	Dimming mode: Non-Dimming Power: 100W Input voltage: AC220-240V Output voltage: DC24V Output current: ≤4.25A Size: 316*30*7*22.8mm Certification: ENEC,CE,CB,RCM, UKCA,MM,CCC
	Ceiling plate (incl. rod&wire)	PP-G	Material: Fe/spraying Maximum weight capacity: 3Kg Size: Ceiling Plate: D88*29mm/Rod: 1-2 meter adjustable/Wire: D3*2000mm Open hole: D75mm Quantity: 1PCS/set		Power supply	LF-GHY240H24	Dimming mode: Non-Dimming Power: 240W Input voltage: AC220-240V Output voltage: DC24V Output current: ≤10A Size: 361*33*1*22.8mm Certification: ENEC,CE,CB,RCM, UKCA,MM,CCC
	Linear power Box (incl. wire)	PB-09	Material: SPCC/spraying Maximum weight capacity: 8Kg Size: Power Box: L401*W50*H46mm Wire: D3*2000mm Quantity: 1PCS/set		Power supply	BK-MGV100-24VOM	Dimming mode: 1-10V Dimming Power: 100W Input voltage: AC220-240V Output voltage: DC24V Output current: ≤4.2A Size: 355*30*21mm Certification: TUV, CE, RCM
	Linear power box (incl. rod&wire)	PB-10	Material: SPCC/spraying Size: Power Box: L401*W50*H46mm Rod: 1-2 meter adjustable Wire: D3*2000mm Quantity: 1PCS/set		Power supply	BK-MEV200-24VOM	Dimming mode: 1-10V Dimming Power: 200W Input voltage: AC220-240V Output voltage: DC24V Output current: ≤8.3A Size: 321.5*48*30mm Certification: CE, ENEC, UKCA, RCM, CCC, EL
	Pendant rod	PG-I	Rod Size: 1-2 meter adjustable Quantity: 2PCS/set		Power supply	BK-DGV100-24VOD	Dimming mode: DALI Dimming Power: 100W Input voltage: AC220-240V Output voltage: DC24V Output current: ≤4.2A Size: 355*30*21mm Certification: CE, ENEC, UKCA, RCM, CCC, EL
	Pendant rope	PN-D	Steel Wire Rope: 2M Maximum weight capacity: 17.5Kg Quantity: 2PCS/set		Power supply	BK-DEV200-24VOD	Dimming mode: DALI2, PUSH-dimming, 1-10V 3in1 dimming Power: 200W Input voltage: AC220-240V Output voltage: DC24V Output current: ≤8.3A Size: 361*33*1*22.8mm Certification: TUV, CE, RCM
	Pendant clips	CP-55	Material: SUS304 Size: L57.8*W20*H5.4mm Quantity: 4PCS/set		CCT control receiver	CR2-GBA	Input voltage: 24VDC Max load current: 8A*3CH, Max 18A Max load power: 384W@24V Operating temperature: -30 C ~ 55 C Product Size: L175*W50*H23mm
	Splicing bars	EX-E20	Applicable product model: CS7070 Material: SPCC/ Electrophoresis Size: L66.8*W30*H15.7mm Quantity: 1 PCS/set		CCT Remote	CK2-GBA	Operating Voltage: 3VDC Working frequency: 2.4GHz Remote control distance: 30m Operating temperature: -30 C ~ 55 C Product Size: L107*W58.5*H9mm
	Diffuser	CV-CS7035D	Material: Silicone Light transmittance: ≥55% Size: 20000*67.2*5mm				

# CEXX35 Series Recessed Lighting Solution

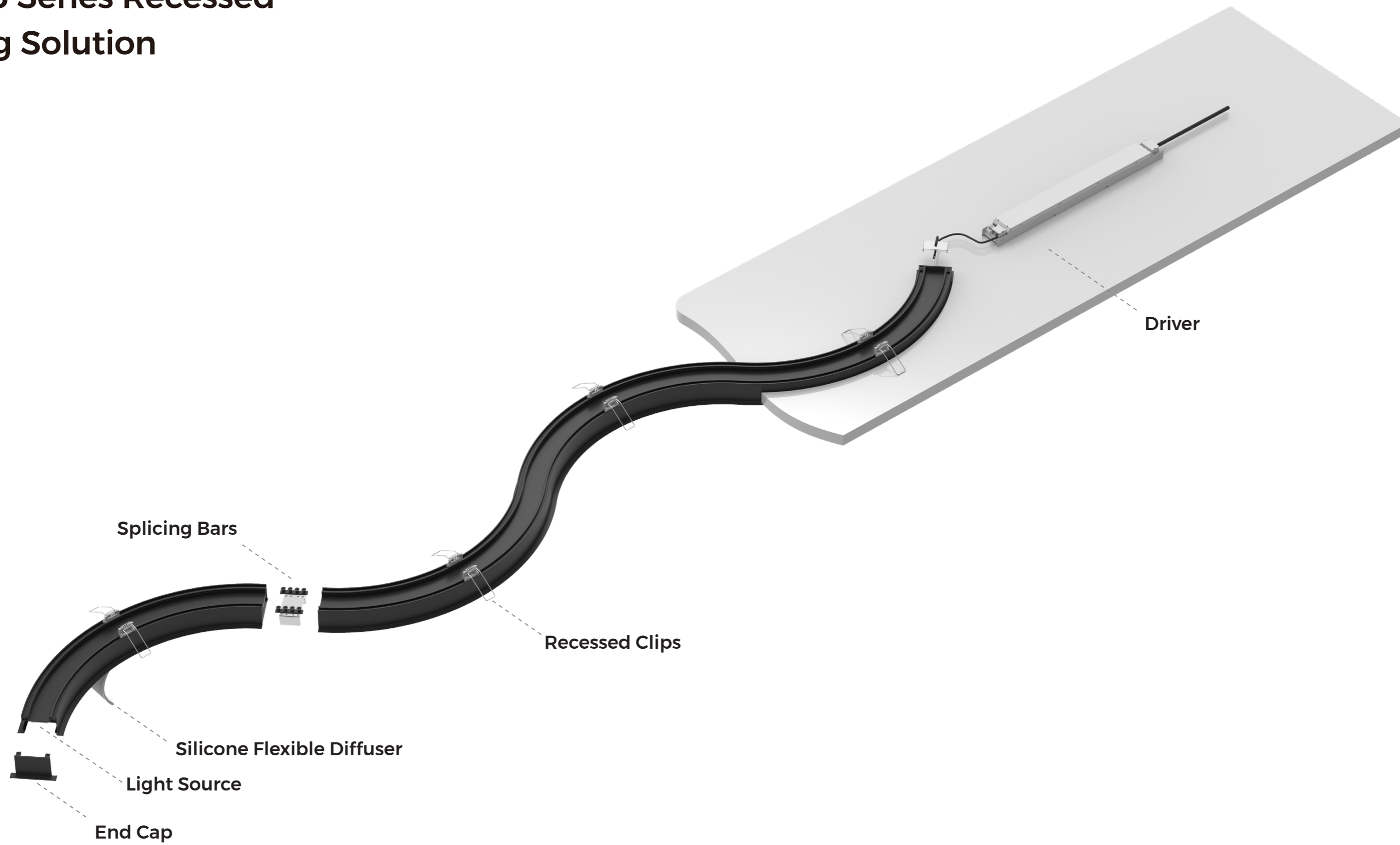

# CE3535 Series

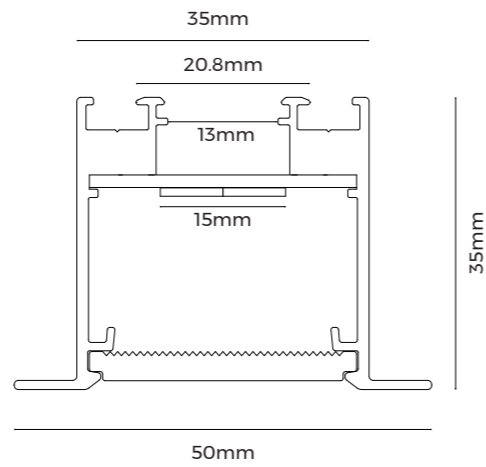
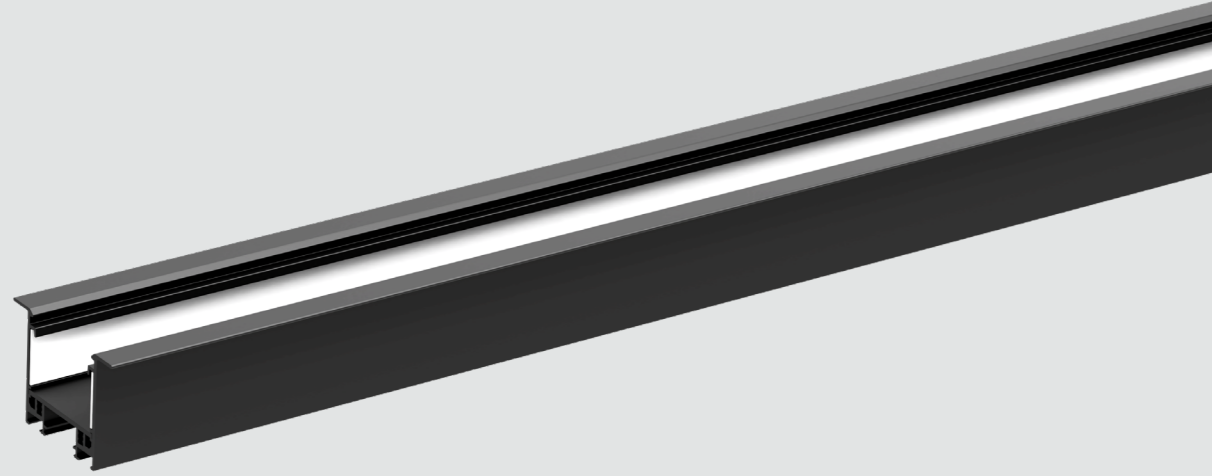

## Parameters

Material	AL6063-T5, Spraying
Light efficiency	70LM/W (RA80,4000K White)
Coating	White(RAL9003) ○ Black(RAL9005) ● Silver(RAL9006) ●
Installation	Recessed
Lighting direction	Downward
Application	Indoor
Certification	ROHS, Reach
IP Grade	IP20
Warranty	5 years

## CE3535

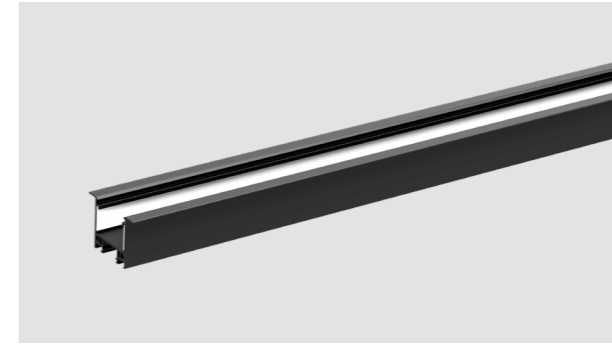

### Dimension(length)

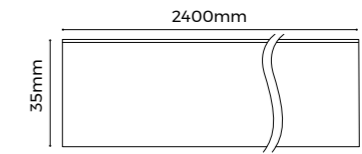

## CE3535-A45



### Dimension(external diameter)

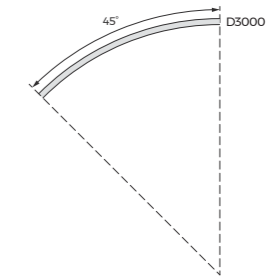

## CE3535-A60

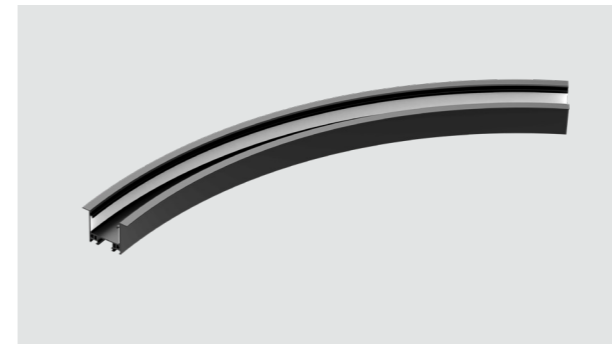

### Dimension(external diameter)

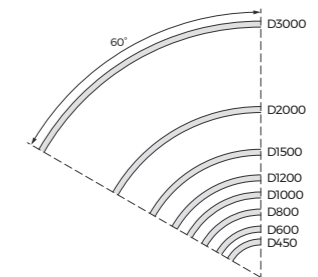

## CE3535-A90



### Dimension(external diameter)

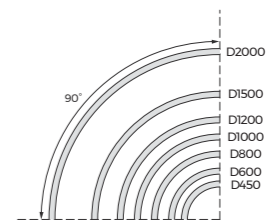

## CE3535-A120



Dimension(external diameter)

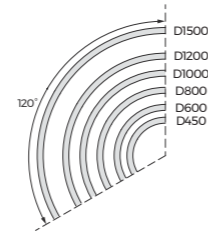

## CE3535-A180

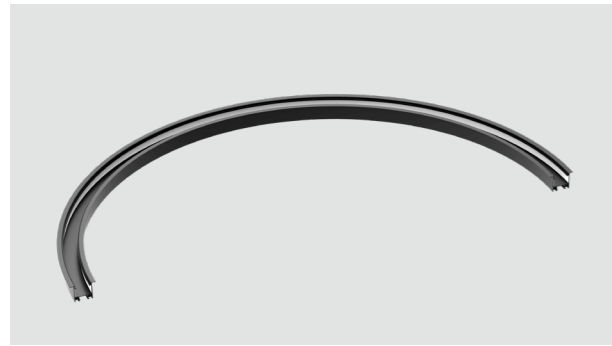

Dimension(external diameter)

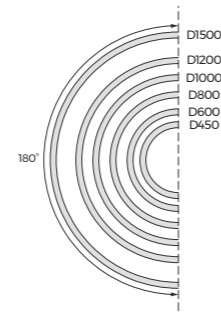

## Light Distribution

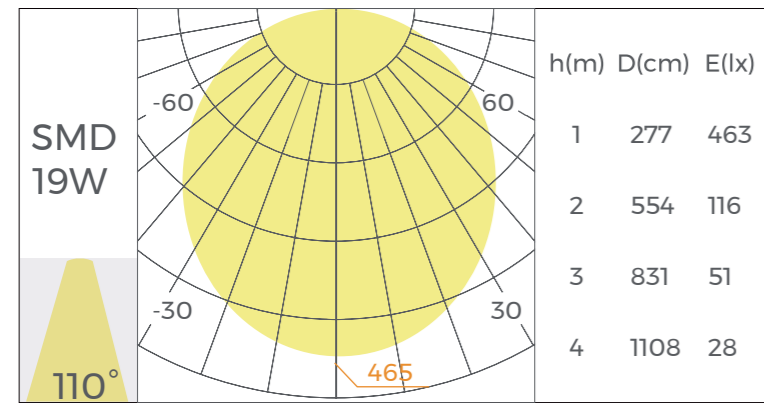

\*The above data is based on a 1000mm length luminaire with Ra80,4000K.

### Lighting Source

Picture	Model	LEDs/pcs	CRI	CCT	Voltage	Typ.power	Max.power	Lumens(RA80)	Size	Cutting unit
	DS8160-24V-15mm	160LEDs/M	80/90	2700/3000K 3500/4000K 5000/6500K	24V	19.2W/M	22.1W/M	2900lm/M(4000K)	5000x15x1.5mm	50mm/8Leds
	DS8320-24V-15mm	320LEDs/M	80/90	2700K+6500K	24V	38.4W/M	42.2W/M	2701lm/M(2700K) 2910lm/M(6500K)	4000x15x1.5mm	50mm/6Leds
	DA168-24V-15mm	168LEDs/M	NO	RGB	24V	20W/M	22W/M	756lm/M(RGB)	5000x15x1.5mm	35.7mm/6Leds
	DMA120-24V-15mm	120LEDs/M	NO	RGB(DMX)	24V	25W/M	27.5W/M	724lm/M(RGB)	4000x15x1.5mm	50mm/6Leds

## Accessory

Picture	Name	Model	Description	Picture	Name	Model	Description
	Recessed	RB-04	Suitable for CE3535/CE5035/CE7035 recessed accessory Quantity: 4PCS/set		Power supply	BK-DGV100-24V0D	Dimming mode: DALI Dimming Power: 100W Input voltage: AC200-240V Output voltage: DC24V Output current: ≤4.2A Size: 355*30*21mm Certification: CE, ENEC, UKCA, RCM, CCC, EL
	Pendant clips	CP-53	Material: SUS304 Size: L22.67*W20*H5.3mm Quantity: 4PCS/set		Power supply	BK-DEV200-24V0D	Dimming mode: DALI2, PUSH-dimming, 1-10V 3in1 dimming Power: 200W Input voltage: AC200-240V Output voltage: DC24V Output current: ≤8.3A Size: 361*33.1*22.8mm Certification: TUV, CE, RCM
	Splicing bars	EX-E15	Applicable product model: CS3535/CE3535 Material: SPCC/ Electrophoresis Size: L31.5*W30*H8mm Quantity: 1 PCS/set		CCT control receiver	CR2-GBA	Input voltage: 24VDC Max load current: 8A*3CH, Max 18A Max load power: 384W@24V Operating temperature: -30°C-55°C Product Size: L175*W50*H23mm
	Diffuser	CV-CS3535D	Material: Silicone Light transmittance: ≥55% Size: 20000*32*3.5mm		CCT Remote	CK2-GBA	Operating Voltage: 3VDC Working frequency: 2.4GHz Remote control distance: 30m Operating temperature: -30°C-55°C Product Size: L107*W58.5*H9mm
	End Caps	EC-ME3535	Material: Aluminum/spraying Size: L50*W55*H2.5mm Quantity: 2 PCS/set		RGB control receiver	CR3-GBA	Input Voltage: 12-48V Output Current: 6A*3CH, Max 18A Output Power: 216W/32W@12V/24V, 648W/864@36V/48V Dimming Mode: RGB/RF2.4G remote control IP: IP20 Product Size: L175*W45*H27mm
	Power supply	LF-GHY100H24	Dimming mode: Non-Dimming Power: 100W Input voltage: AC220-240V Output voltage: DC24V Output current: ≤4.25A Size: 316*30.7*22.8mm Certification: ENEC, CE, CB, RCM, UKCA, MM, CCC		RGBW Remote	R8-1	Working Voltage: 3VDC (Battery CR2032) Operating Frequency: 2.4GHz Remote Control Distance: 30m Operating Temperature: -30°C-55°C Product Size: L107*W58.5*H9mm
	Power supply	LF-GHY240H24	Dimming mode: Non-Dimming Power: 240W Input voltage: AC220-240V Output voltage: DC24V Output current: ≤10A Size: 361*33.1*22.8mm Certification: ENEC, CE, CB, RCM, UKCA, MM, CCC		Programmable digital controller	K-1000C	Input voltage: 5-24V Control Pixel Points: Point Control 1CH*1024(SPI), Point Control 1CH*512(DMX) Dimming mode: DMX/SPI control IP: IP20 Warranty: 5 years
	Power supply	BK-MGV100-24V0M	Dimming mode: 1-10V Dimming Power: 100W Input voltage: AC200-240V Output voltage: DC24V Output current: ≤4.2A Size: 355*30*21mm Certification: TUV, CE, RCM		Programmable digital controller	K-8000C	Input Voltage: 5-24V Control Pixel Points: Point Control 8CH*1024(SPI), Point Control 8CH*512(DMX) Dimming mode: DMX/SPI control IP: IP20 Warranty: 5 years
	Power supply	BK-MEV200-24V0M	Dimming mode: 1-10V Dimming Power: 200W Input voltage: AC200-240V Output voltage: DC24V Output current: ≤8.3A Size: 321.5*48*30mm Certification: CE, ENEC, UKCA, RCM, CCC, EL				

# CE5035 Series

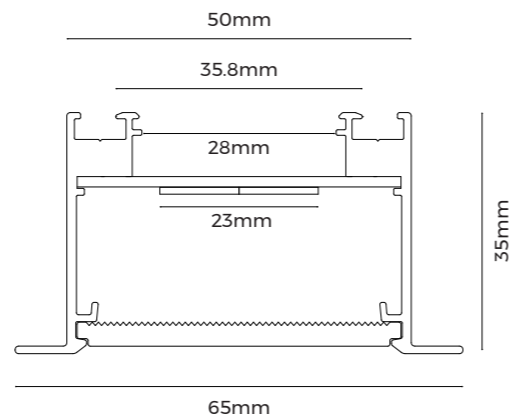

Parameters	
Material	AL6063-T5, Spraying
Light efficiency	90LM/W (RA80,4000K White)
Coating	White(RAL9003) ○ Black(RAL9005) ● Silver(RAL9006) ●
Installation	Recessed
Lighting direction	Downward
Application	Indoor
Certification	ROHS, Reach
IP Grade	IP20
Warranty	5 years

## CE5035

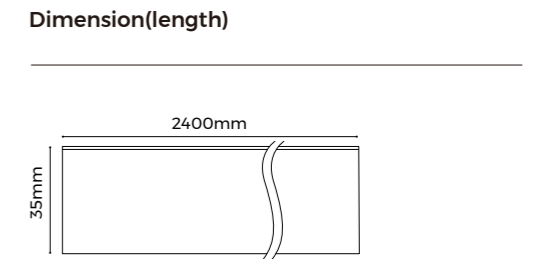
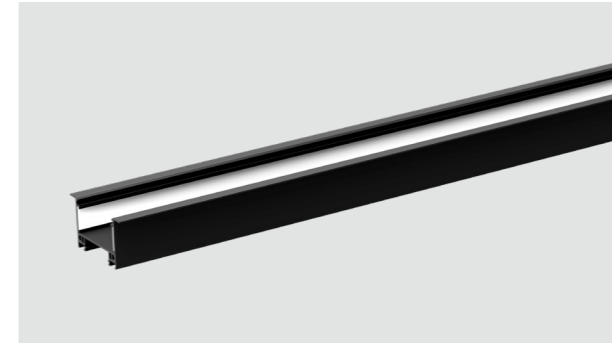

## CE5035-A45

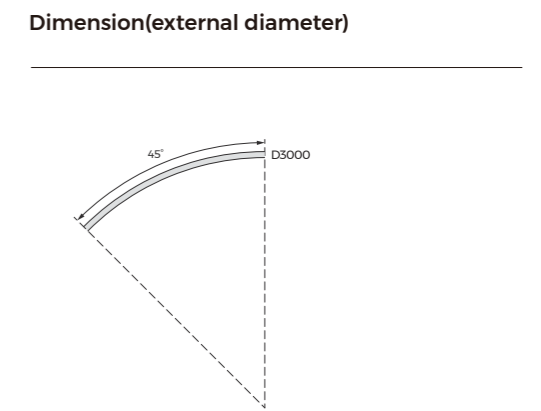

## CE5035-A60

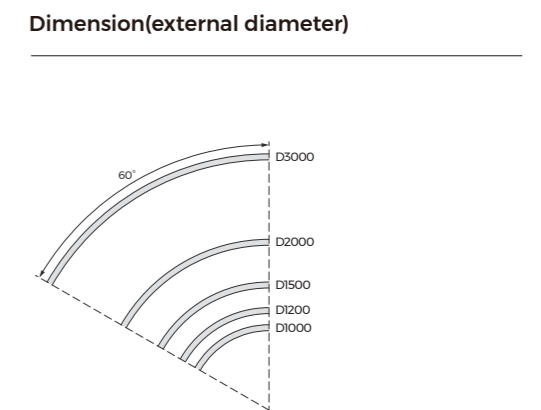
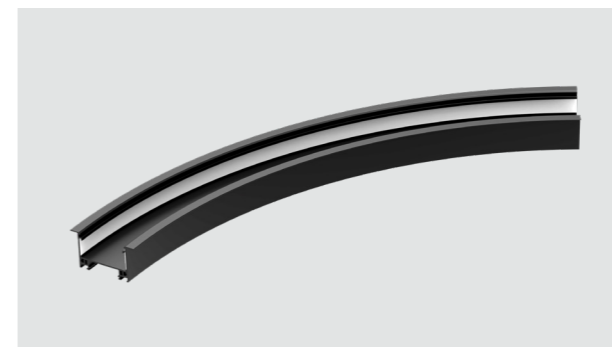

## CE5035-A90

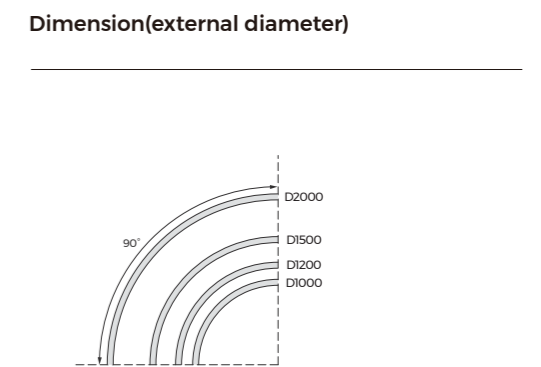

## CE5035-A120



Dimension(external diameter)

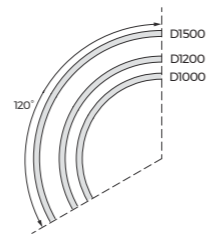

## CE5035-A180

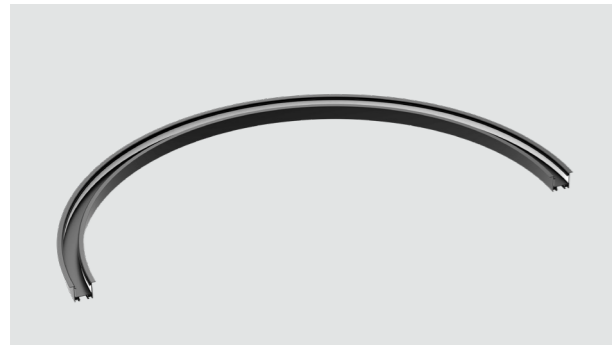

Dimension(external diameter)

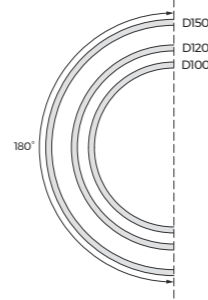

## Light Distribution

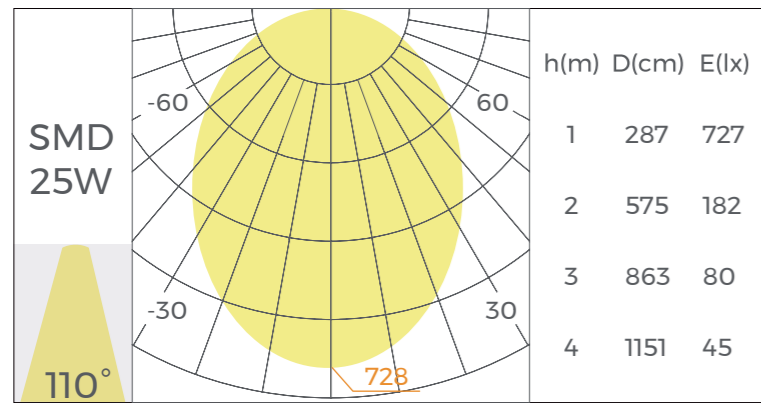

\*The above data is based on a 1000mm length luminaire with Ra80,4000K.

### Lighting Source

Picture	Model	LEDs/pcs	CRI	CCT	Voltage	Typ.power	Max.power	Lumens	Size	Cutting unit
	DS8160-24V-23mm	160LEDs/M	80/90	2700/3000K 3500/4000K 5000/6500K	24V	24W/M	26.4W/M	3600lm/M(4000K)	4000x23x1.5mm	50mm/8Leds
	DS8320-24V-23mm	320LEDs/M	80/90	2700K+6500K	24V	48W/M	52.8W/M	3240lm/M(2700K) 3408lm/M(6500K)	3000x23x1.5mm	50mm/16Leds

## Accessory

Picture	Name	Model	Description	Picture	Name	Model	Description
	Recessed	RB-04	Suitable for CE5535/CE5035/CE7035 recessed accessory Quantity: 4PCS/set		Power supply	BK-MCV100-24V0M	Dimming mode: 1-10V Dimming Power: 100W Input voltage: AC200-240V Output voltage: DC24V Output current: <math>\leq 2A</math> Size: 355*50*21mm Certification: TUV, CE, RCM
	Pendant clips	CP-54	Material: SUS304 Size: L37.87*W20*H5.4mm Quantity: 4PCS/set		Power supply	BK-MEV200-24V0M	Dimming mode: 1-10V Dimming Power: 200W Input voltage: AC200-240V Output voltage: DC24V Output current: <math>\leq 3.3A</math> Size: 321.5*48*50mm Certification: CE, ENEC, UKCA, RCM, CCC, EL
	Splicing bars	EX-E16	Applicable product model: CS5035/CE5035 Material: SPCC/ Electroplating Size: L46.5*W30*H18mm Quantity: 1 PCS/set		Power supply	BK-DCV100-24V0D	Dimming mode: DALI Dimming Power: 100W Input voltage: AC200-240V Output voltage: DC24V Output current: <math>\leq 2A</math> Size: 355*50*21mm Certification: CE, ENEC, UKCA, RCM, CCC, EL
	Diffuser	CV-CS5035D	Material: Silicone Light transmittance: >=55% Size: 2000*47*4mm		Power supply	BK-DEV200-24V0D	Dimming mode: DALI2, PUSH-dimming, 1-10V 3in1 dimming Power: 200W Input voltage: AC200-240V Output voltage: DC24V Output current: <math>\leq 3.3A</math> Size: 361*33.1*22.8mm Certification: TUV, CE, RCM
	End Caps	EC-ME5035	Material: Aluminum/ spraying Size: L65*W55*H2.5mm Quantity: 2PCS/set		CCT control receiver	CR2-CBA	Input voltage: 24VDC Max load current: 8A*3CH, Max 18A Max load power: 384W@24V Operating temperature: -30 C ~ 55 C Product Size: L175*W50*H23mm
	Power supply	LF-GHY100H24	Dimming mode: Non-Dimming Power: 100W Input voltage: AC220-240V Output voltage: DC24V Output current: <math>\leq 4.25A</math> Size: 316*50.7*22.8mm Certification: ENEC, CE, C, RCM, UKCAMM, CCC		CCT Remote	CK2-CBA	Operating Voltage: 3VDC Working frequency: 2.4GHz Remote control distance: 30m Operating temperature: -30 C ~ 55 C Product Size: L107*W58.5*H9mm
	Power supply	LF-GHY240H24	Dimming mode: Non-Dimming Power: 240W Input voltage: AC220-240V Output voltage: DC24V Output current: <math>\leq 10A</math> Size: 361*33.1*22.8mm Certification: ENEC, CE, C, RCM, UKCAMM, CCC				

# CE7035 Series

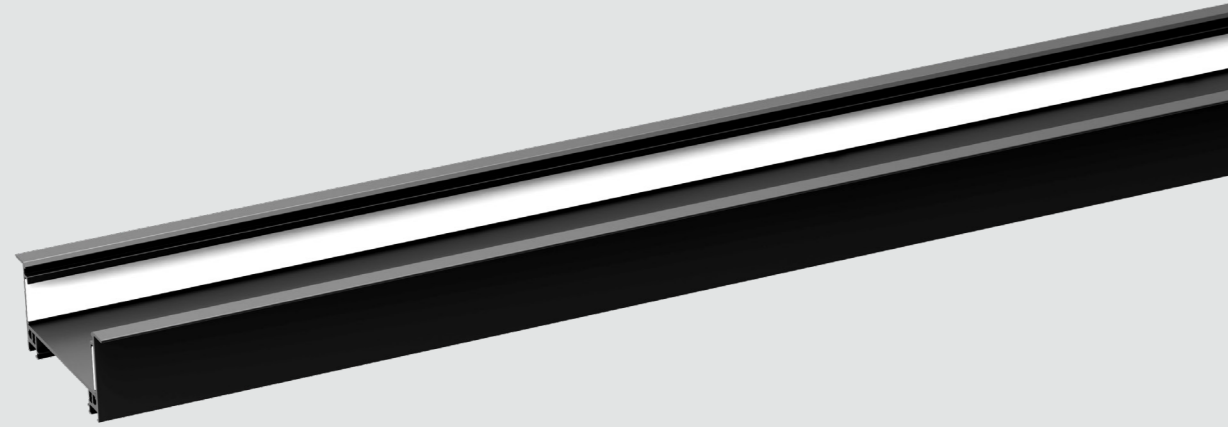

Parameters	
Material	AL6063-T5, Spraying
Light efficiency	85LM/W (RA80,4000K White)
Coating	White(RAL9003) <input type="radio"/> Black(RAL9005) <input checked="" type="radio"/> Silver(RAL9006) <input type="radio"/>
Installation	Recessed
Lighting direction	Downward
Application	Indoor
Certification	ROHS, Reach
IP Grade	IP20
Warranty	5 years

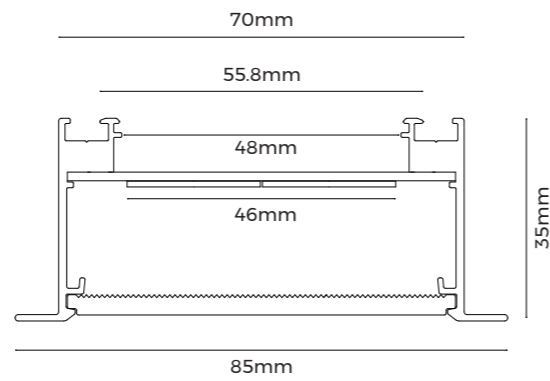

## CE7035

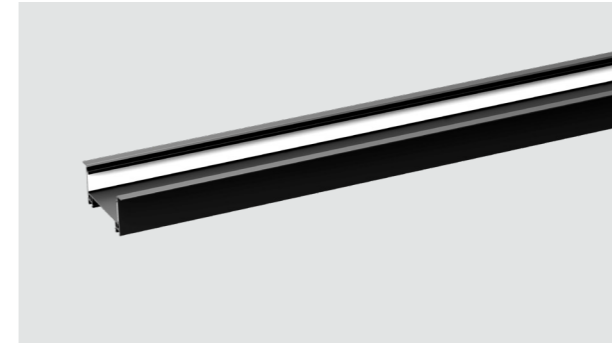

Dimension(length)

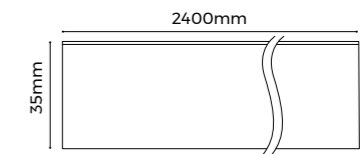

## CE7035-A45



Dimension(external diameter)

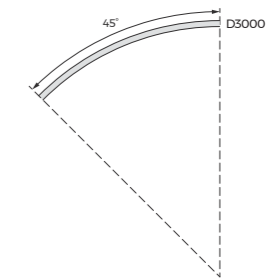

## CE7035-A60



Dimension(external diameter)

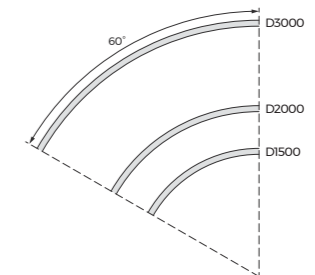

## CE7035-A90



Dimension(external diameter)

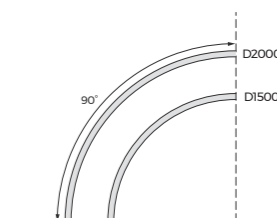

## CE7035-A120

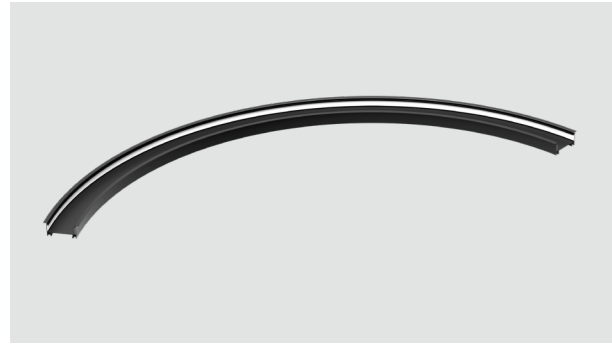

Dimension(external diameter)

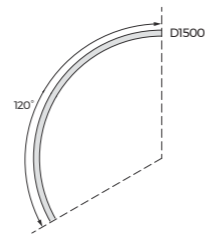

## CE7035-A180

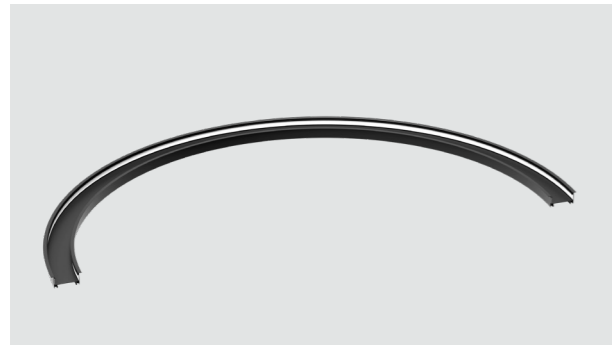

Dimension(external diameter)

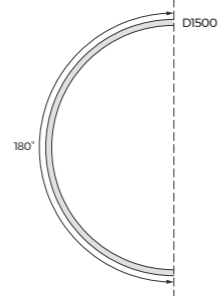

## Light Distribution

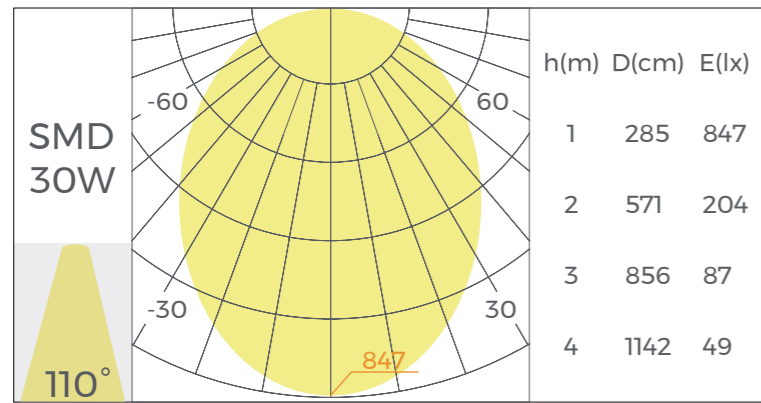

\*The above data is based on a 1000mm length luminaire with Ra80,4000K.

### Lighting Source

Picture	Model	LEDs/pcs	CRI	CCT	Voltage	Typ.power	Typ.power	Lumens	Size	Cutting unit
	DS8160-24V-23mm	160LEDs/M	80/90	2700/3000K 3500/4000K 5000/6500K	24V	14.4W/M	15.8W/M	2300lm/M(4000K)	5000x23x1.5mm	50mm/8Leds
	DS8320-24V-23mm	320LEDs/M	80/90	2700K+6500K	24V	28.8W/M	31.6W/M	1944m/M(2700K) 2131lm/M(6500K)	4000x23x1.5mm	50mm/16Leds

## Accessory

Picture	Name	Model	Description	Picture	Name	Model	Description
	Recessed	RB-04	Suitable for CE3535/CE5035/CE7035 recessed accessory Quantity: 4PCS/set		Power supply	BK-MCV100-24V0M	Dimming mode: 1-10V Dimming Power: 100W Input voltage: AC200-240V Output voltage: DC24V Output current: ≤4.2A Size: 355*50*21mm Certification: TUV, CE, RCM
	Pendant clips	CP-55	Material: SUS304 Size: L57.8*W20*H5.4mm Quantity: 4PCS/set		Power supply	BK-MEV200-24V0M	Dimming mode: 1-10V Dimming Power: 200W Input voltage: AC200-240V Output voltage: DC24V Output current: ≤8.3A Size: 321.5*48*50mm Certification: CE, ENEC, UKCA, RCM, CCC, EL
	Splicing bars	EX-E17	Applicable product model: CS7035/CE7035 Material: SPC/ Electrophoresis Size: L66.5*W50*H18mm Quantity: 1 PCS/set		Power supply	BK-DCV100-24V0D	Dimming mode: DALI Dimming Power: 100W Input voltage: AC200-240V Output voltage: DC24V Output current: ≤4.2A Size: 355*50*21mm Certification: CE, ENEC, UKCA, RCM, CCC, EL
	Diffuser	CV-CS7035D	Material: Silicone Light transmittance: ≥55% Size: 20000*67.2*5mm		Power supply	BK-DEV200-24V0D	Dimming mode: DALI2, PUSH-dimming, 1-10V 3in1 dimming Power: 200W Input voltage: AC200-240V Output voltage: DC24V Output current: ≤8.3A Size: 361*33.1*22.8mm Certification: TUV, CE, RCM
	End Caps	EC-ME7035	Material: Aluminum/spraying Size: L85*W35*H2.5mm Quantity: 2PCS/set		CCT control receiver	CR2-GBA	Input voltage: 24VDC Max load current: 8A*3CH, Max 18A Max load power: 384W@24V Operating temperature: -30°C-55°C Product Size: L175*W50*H23mm
	Power supply	LF-GHY100H24	Dimming mode: Non-Dimming Power: 100W Input voltage: AC220-240V Output voltage: DC24V Output current: ≤4.25A Size: 316*50.7*22.8mm Certification: ENEC, CE, CB, RCM, UKCA, MM, CCC		CCT Remote	CK2-GBA	Operating Voltage: 3VDC Working frequency: 2.4GHz Remote control distance: 30m Operating temperature: -30°C-55°C Product Size: L107*W58.5*H9mm
	Power supply	LF-GHY240H24	Dimming mode: Non-Dimming Power: 240W Input voltage: AC220-240V Output voltage: DC24V Output current: ≤10A Size: 361*33.1*22.8mm Certification: ENEC, CE, CB, RCM, UKCA, MM, CCC				